

POLYGONAL ER COLLET CHUCK

SPANNZANGENFUTTER MIT POLYGONSCHAFT

PORTAPINZE TIPO ER CON ATTACCO POLIGONALE

PORTAPINZAS ER CON SUJECION POLIGONAL

PORTE-PINCES AVEC ATTACHEMENT POLYAGONALE

ЦАНГОВЫЕ ПАТРОНЫ С ПОЛИГОНАЛЬНЫМ ХВОСТОВИКОМ

多边形 ER 筒夹

DIN ISO 26623-1

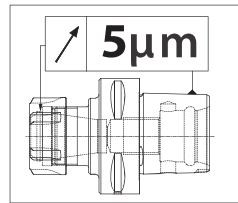
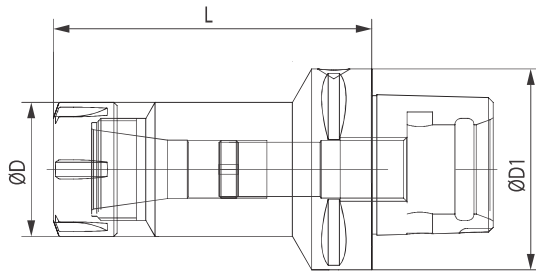

CODE N.	ATTACCO SHANK	PER PINZA FOR COLLET	D1 mm	D mm	L mm	G6,3 8000
C40H70ER16	C40	ER16	40	32	70	•
C40H52ER20	C40	ER20	40	35	52	•
C40H52ER25	C40	ER25	40	42	52	•
C40H54ER32	C40	ER32	40	50	54	•
C50H60ER16	C50	ER16	50	32	60	•
C50H60ER20	C50	ER20	50	35	60	•
C50H60ER25	C50	ER25	50	42	60	•
C50H60ER32	C50	ER32	50	50	60	•
C50H65ER40	C50	ER40	50	63	65	•
C50H100ER16	C50	ER16	50	32	100	•
C50H100ER25	C50	ER25	50	42	100	•
C50H100ER20	C50	ER20	50	35	100	•
C50H100ER32	C50	ER32	50	50	100	•
C50H100ER40	C50	ER40	50	63	100	•
C63H60ER16	C63	ER16	63	32	60	•
C63H60ER20	C63	ER20	63	35	60	•
C63H60ER25	C63	ER25	63	42	60	•
C63H60ER32	C63	ER32	63	50	60	•
C63H70ER40	C63	ER40	63	63	70	•
C63H100ER16	C63	ER16	63	32	100	•
C63H100ER20	C63	ER20	63	35	100	•
C63H100ER25	C63	ER25	63	42	100	•
C63H100ER32	C63	ER32	63	50	100	•
C63H130ER40	C63	ER40	63	63	130	•
C80H70ER32	C80	ER32	80	50	70	•
C80H70ER40	C80	ER40	80	63	70	•

Accessories
Accessori
Zubehör
Accesorios
Accessoires
Принадлежности
零件



Spare parts • Componenti • Ersatzteile • Piezas de repuesto
Pièces détachées • Запасные части • 零件

ER	NUT	STOP SCREW
16	812-203005	811-303119
20	812-203006	811-303120
25	812-203001	811-303121
32	812-203002	811-303118
40	812-203003	811-303122

COLLET CHUCK KITS

SPANNFUTTERSATZ

KIT PORTAPINZE

SET DE PORTAPINZAS

JEUX PORTE-PINCES

НАБОРЫ ОПРАВОК С ЦАНГАМИ

夹头变径套组套

DIN ISO 26623-1

CODE N.	DESCRIPTION
KITC50H60ER16	C50H60ER16+10 collets (ER16d.1-2-3-4-5-6-7-8-9-10) + wrench
KITC50H60ER25	C50H60ER25+10 collets (ER25d.2-3-4-5-6-8-10-12-14-16) + wrench
KITC50H60ER32	C50H60ER32+10 collets (ER32d.3-4-6-8-10-12-14-16-18-20) + wrench
KITC50H100ER16	C50H100ER16+10 collets (ER16d.1-2-3-4-5-6-7-8-9-10) + wrench
KITC50H100ER25	C50H100ER25+10 collets (ER25d.2-3-4-5-6-8-10-12-14-16) + wrench
KITC50H100ER32	C50H100ER32+10 collets (ER32d.3-4-6-8-10-12-14-16-18-20) + wrench
KITC63H60ER16	C63H60ER16+10 collets (ER16d.1-2-3-4-5-6-7-8-9-10) + wrench
KITC63H60ER25	C63H60ER25+10 collets (ER25d.2-3-4-5-6-8-10-12-14-16) + wrench
KITC63H60ER32	C63H60ER32+10 collets (ER32d.3-4-6-8-10-12-14-16-18-20) + wrench
KITC63H100ER16	C63H100ER16+10 collets (ER16d.1-2-3-4-5-6-7-8-9-10) + wrench
KITC63H100ER25	C63H100ER25+10 collets (ER25d.2-3-4-5-6-8-10-12-14-16) + wrench
KITC63H100ER32	C63H100ER32+10 collets (ER32d.3-4-6-8-10-12-14-16-18-20) + wrench

Kit Box: 1 Collet chuck + 10 Collets + Wrench
Cassetta corredo: 1 Portapinze + 10 pinze + chiave
Ausstattungskasten: 1 Spannzangenfutter + 10 Spannzangen + Spannschlüssel
Contenido del set: 1 Cono Portapinzas + 10 Pinzas + Llave
Boite d'équipement: 1 Porte-pince + 10 pinces + Clé de serrage
Набор: из цангового патрона и цанг
套装: 1 刀柄 + 10 夹头 + 1 扳手





ER MINI COLLET CHUCK

SPANNZANGENFUTTER ER MINI MANDRINI PORTAPINZA TIPO ER MINI EXTRA SOTTILI
 CONOS PORTAPINZAS TIPO ER MINI MANDRINS A PINCES TYPE ER MINI
 ЦАНГОВЫЕ МИНИ-ПАТРОНЫ ER ER 迷你弹簧夹头

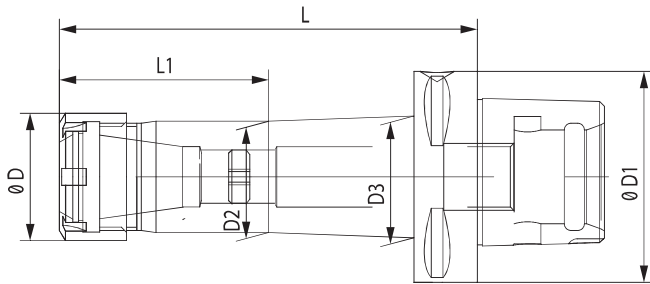
DIN 6499



Spare parts • Componenti • Ersatzteile • Piezas de repuesto
 Pièces détachées • Запасные части • 零件

ER	NUT	STOP SCREW
		
11M	812-203012	811-303081
16M	812-203013	811-303119
20M	812-203014	811-303120
25M	812-203015	811-303121

CODE N.	ATTACCO SHANK	ER	D1	D	L	L1	D2	D3
C50H100ER11M	C50	11M	50	16	100	40	14	20
C50H100ER16M	C50	16M	50	22	100	42	20	25
C50H100ER20M	C50	20M	50	28	100	48	26	30
C50H100ER25M	C50	25M	50	35	100	-	33	-
C50H160ER11M	C50	11M	50	16	160	50	14	23
C50H160ER16M	C50	16M	50	22	160	97	20	26
C50H160ER20M	C50	20M	50	28	160	98	26	31
C50H160ER25M	C50	25M	50	35	160	103	33	35
C63H100ER11M	C63	11M	63	16	100	40	14	20
C63H100ER16M	C63	16M	63	22	100	42	20	25
C63H100ER20M	C63	20M	63	28	100	48	26	30
C63H100ER25M	C63	25M	63	35	100	-	33	-
C63H160ER11M	C63	11M	63	16	160	50	14	23
C63H160ER16M	C63	16M	63	22	160	97	20	26
C63H160ER20M	C63	20M	63	28	160	98	26	31
C63H160ER25M	C63	25M	63	35	160	103	33	35

POLYGONAL END MILL HOLDER WELDON

WELDON SPANNFUTTER MIT POLYGONSCHAFT PORTAFRESE WELDON CON ATTACCO POLIGONALE
 CONOS PORTAFRESAS TIPO WELDON CON MANGO POLYGONAL PORTE-FRAISES WELDON CON ATTACHEMENT POLYGONALE
 CONOS WELDON CON SUJECION POLIGONAL PATRONES EPS PARA CONOS DE FRESE CON CODO WELDON
 多边形威尔登式铣刀柄

DIN ISO 26623-1

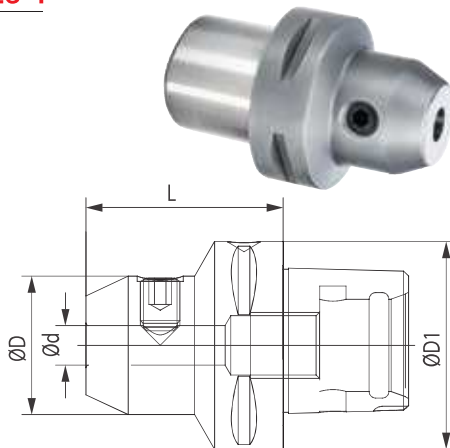

Spare parts • Componenti • Ersatzteile • Piezas de repuesto
 Pièces détachées • Запасные части • 零件

d	LOCKING SCREW	QUANTITY
		
6	811-106001	1
8	811-106002	1
10	811-106004	1
12;14	811-106005	1
16;18	811-106006	1
20	811-106007	1
25	811-106008	2
32;40	811-106009	2

CODE N.	ATTACCO SHANK	D1 mm	D mm	d mm	L mm	G6,3 8000
C40H50WE06	C40	40	25	6	50	•
C40H50WE08	C40	40	28	8	50	•
C40H50WE10	C40	40	35	10	50	•
C40H55WE12	C40	40	42	12	55	•
C40H55WE16	C40	40	48	16	55	•
C50H55WE06	C50	50	25	6	55	•
C50H55WE08	C50	50	28	8	55	•
C50H65WE10	C50	50	35	10	65	•
C50H65WE12	C50	50	42	12	65	•
C50H65WE14	C50	50	42	14	65	•
C50H65WE16	C50	50	48	16	65	•
C50H65WE18	C50	50	48	18	65	•
C50H65WE20	C50	50	52	20	65	•
C50H80WE25	C50	50	65	25	80	•
C63H55WE06	C63	63	25	6	55	•
C63H55WE08	C63	63	28	8	55	•
C63H60WE10	C63	63	35	10	60	•
C63H60WE12	C63	63	42	12	60	•
C63H60WE14	C63	63	44	14	60	•
C63H65WE16	C63	63	48	16	65	•
C63H65WE20	C63	63	52	20	65	•
C63H80WE25	C63	63	64	25	80	•
C63H90WE32	C63	63	72	32	90	•
C63H100WE40	C63	63	80	40	100	•
C80H70WE06	C80	80	25	6	70	•
C80H70WE08	C80	80	28	8	70	•
C80H70WE10	C80	80	35	10	70	•
C80H70WE12	C80	80	42	12	70	•
C80H70WE14	C80	80	44	14	70	•
C80H70WE16	C80	80	48	16	70	•
C80H70WE20	C80	80	50	20	70	•
C80H80WE25	C80	80	52	25	80	•
C80H80WE32	C80	80	72	32	80	•
C80H110WE40	C80	80	80	40	110	•

DOUBLE CONTACT ER COLLET CHUCK

DOPPELKONTAKT AUFNAHMEN ER SPANNZANGENFUTTER
CONOS PORTAPINZAS DE DOBLE CONTACTO DE TIPO ER
ЦАНГОВЫЙ ПАТРОН ER С ДВОЙНЫМ КОНТАКТОМ

MANDRINI PORTAPINZA A DOPPIO CONTATTO TIPO ER
MADRINS DOUBLE CONTACT PORTE-PINCE ER
ER双向夹头

MAS BT AD+B DOPPIO CONTATTO - DIN 6499

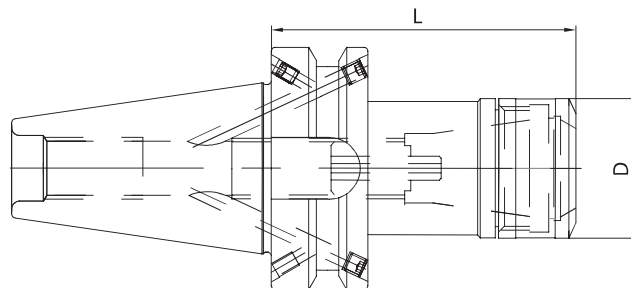

DOUBLE CONTACT

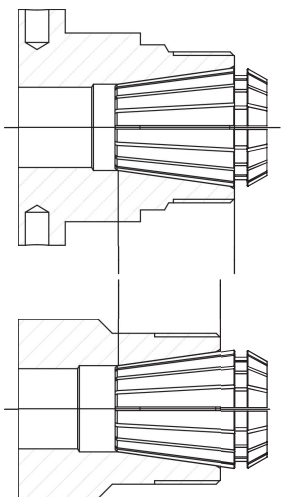

HIGH
PRECISION
LINE

STANDARD

	CODE N.	DESCRIPTION	ISO	L	D	ER	G2,5 30000
ISO 30	214-37231*	BT30H70ER16-HPDK	30	70	30	16	•
	214-37232*	BT30H70ER25-HPDK	30	70	40	25	•
	214-37233*	BT30H70ER32-HPDK	30	70	50	32	•
ISO 40	214-37219	BT40H70ER16-HPDK	40	70	30	16	•
	214-37220	BT40H70ER25-HPDK	40	70	40	25	•
	214-37221	BT40H70ER32-HPDK	40	70	50	32	•
ISO 40	214-37222	BT40H100ER16-HPDK	40	100	30	16	•
	214-37223	BT40H100ER25-HPDK	40	100	40	25	•
	214-37224	BT40H100ER32-HPDK	40	100	50	32	•
ISO 50	214-37225	BT50H80ER16-HPDK	50	80	30	16	•
	214-37226	BT50H80ER25-HPDK	50	80	40	25	•
	214-37227	BT50H80ER32-HPDK	50	80	50	32	•
ISO 50	214-37228	BT50H100ER16-HPDK	50	100	30	16	•
	214-37229	BT50H100ER25-HPDK	50	100	40	25	•
	214-37230	BT50H100ER32-HPDK	50	100	50	32	•

- * BT30 only AD version
- * BT30 solo versione AD
- * BT30 nur AD Ausführung
- * BT30 solo versión AD
- * BT30 seulement Version AD
- * BT30 только с AD исполнением
- * BT30 只在AD版本下

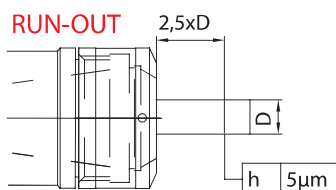

Accessories
Accessori
Zubehör
Accessorios
Accessoires
Принадлежности
零件



pag. 178



pag. 178

COLLETS ER TYPE

ER TYP SPANNZANGEN PINZE TIPO ER
PINZAS TIPO ER PINCES TYPE ER
НАБОРЫ ЦАНГ ER ER 类型的夹头

CODE N.	D	L	ER
812-203085	30	18	16
812-203086	40	20,5	25
812-203087	50	23,5	32

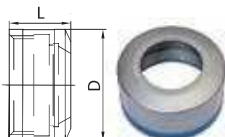

WRENCHES FOR NUT

SPANNSCHLÜSSEL FÜR SPANNMUTTER CHIAVI PER GHIERA
LLAVES PARA TUERCA CLES DE SERRAGE POUR ECROU
КЛЮЧИ ДЛЯ СТАНДАРТНЫХ ГАЕК 标准螺母用扳手

CODE N.	D	D1	ER
816-203069	30	3	16
816-203070	40	4	25
816-203071	50	4	32



DOUBLE CONTACT ER COLLET CHUCK

DOPPELKONTAKT AUFNAHMEN ER SPANNZANGENFUTTER
 CONOS PORTAPINZAS TIPO ER DE DOBLE CONTACTO
 ЦАНГОВЫЙ ПАТРОН ER С ДВОЙНЫМ КОНТАКТОМ

MANDRINI PORTAPINZA A DOPPIO CONTATTO TIPO ER
 MADRINS DOUBLE CONTACT PORTE-PINCE ER
 ER双向夹头

DIN69871 AD+B DOPPIO CONTATTO - DIN 6499

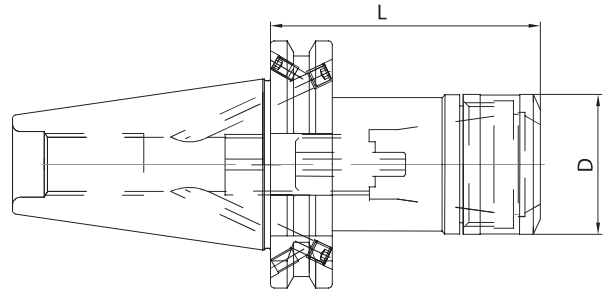

DOUBLE CONTACT

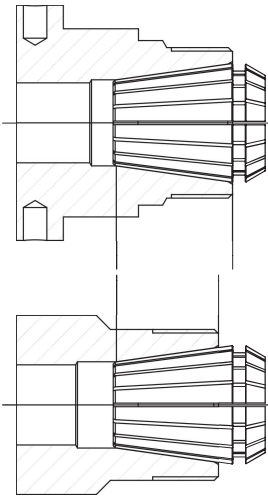

HIGH
PRECISION
LINE

STANDARD

	CODE N.	DESCRIPTION	ISO	L	D	ER	G2,5 30000
ISO40	214-37115	TC40H70ER16-HPDK	40	70	30	16	•
	214-37116	TC40H70ER25-HPDK	40	70	40	25	•
	214-37117	TC40H70ER32-HPDK	40	70	50	32	•
ISO 40	214-37118	TC40H100ER16-HPDK	40	100	30	16	•
	214-37119	TC40H100ER25-HPDK	40	100	40	25	•
	214-37120	TC40H100ER32-HPDK	40	100	50	32	•
ISO 50	214-37121	TC50H80ER16-HPDK	50	80	30	16	•
	214-37122	TC50H80ER25-HPDK	50	80	40	25	•
	214-37123	TC50H80ER32-HPDK	50	80	50	32	•
ISO 50	214-37124	TC50H100ER16-HPDK	50	100	30	16	•
	214-37125	TC50H100ER25-HPDK	50	100	40	25	•
	214-37126	TC50H100ER32-HPDK	50	100	50	32	•

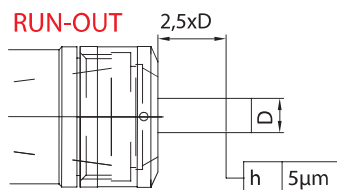

Accessories
 Accessori
 Zubehör
 Accessoires
 Принадлежности
 零件



COLLETS ER TYPE

ER TYP SPANNZANGEN PINZE TIPO ER
 PINZAS TIPO ER PINCES TYPE ER
 НАБОРЫ ЦАНГ ER ER 类型的夹头

CODE N.	D	L	ER
812-203085	30	18	16
812-203086	40	20,5	25
812-203087	50	23,5	32

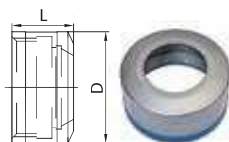

WRENCHES FOR NUT

SPANNSCHLÜSSEL FÜR SPANNMUTTER CHIAVI PER GHIERA
 LLAVES PARA TUERCA CLES DE SERRAGE POUR ECROU
 КЛЮЧИ ДЛЯ СТАНДАРТНЫХ ГАЕК 标准螺母用扳手

CODE N.	D	D1	ER
816-203069	30	3	16
816-203070	40	4	25
816-203071	50	4	32



DOUBLE CONTACT ER COLLET CHUCK



DOPPELKONTAKT AUFNAHMEN ER SPANNZANGENFUTTER
CONOS PORTAPINZAS TIPO ER DE DOBLE CONTACTO
ЦАНГОВЫЙ ПАТРОН ER С ДВОЙНЫМ КОНТАКТОМ

MANDRINI PORTAPINZA A DOPPIO CONTATTO TIPO ER
MADRINS DOUBLE CONTACT PORTE-PINCE ER
ER双向夹头

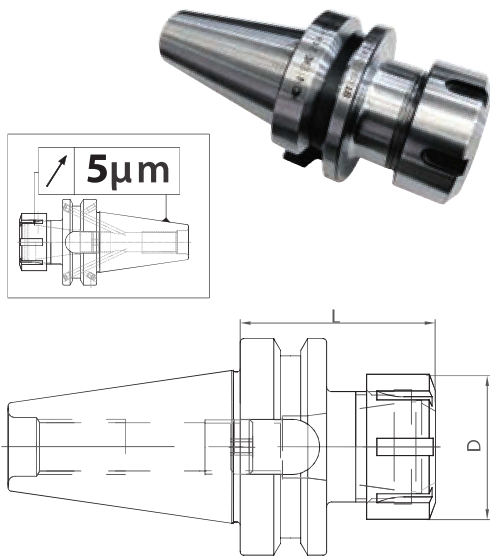
MAS 403/BT AD

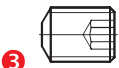
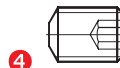

CODE N.	DESCRIPTION	ISO	ER	D	L	G2,5 30000 RPM
214-37201	BT30H70ER16 AD	30	16	32	70	•
214-37202	BT30H70ER20 AD	30	20	35	70	•
214-37203	BT30H70ER25 AD	30	25	42	70	•
214-37204	BT30H70ER32 AD	30	32	50	70	•
214-37205	BT40H70ER16 AD	40	16	32	70	•
214-37206	BT40H70ER25 AD	40	25	42	70	•
214-37207	BT40H70ER32 AD	40	32	50	70	•
214-37208	BT40H70ER40 AD	40	40	63	70	•
214-37209	BT40H100ER16 AD	40	16	32	100	•
214-37210	BT40H100ER25 AD	40	25	42	100	•
214-37211	BT40H100ER32 AD	40	32	50	100	•
214-37212	BT40H100ER40 AD	40	40	63	100	•
214-37213	BT50H80ER32 AD	50	32	50	80	•
214-37214	BT50H80ER40 AD	50	40	63	80	•
214-37215	BT50H100ER32 AD	50	32	50	100	•
214-37216	BT50H100ER40 AD	50	40	63	100	•
214-37217	BT50H160ER32 AD	50	32	50	160	•
214-37218	BT50H200ER32 AD	50	32	50	200	•

TAPE	SCREW	QUANTITY	SCREW	QUANTITY	ER	NUT	STOP SCREW
							
ISO 40	811-102002 M4X5	2	811-102002 M4X5	2	16	812-203080	811-303119
ISO 50	811-102001 M4X4	2	811-102010 M5X6	2	20	812-203081	811-303120
					25	812-203082	811-303121
					32	812-203083	811-303118
					40	812-203084	811-303122

Spare parts • Componenti • Piezas de repuesto • Ersatzteile • Pièces détachées • Запасные части • 零件

DOUBLE CONTACT ER COLLET CHUCK

DOPPELKONTAKT AUFNAHMEN ER SPANNZANGENFUTTER
CONOS PORTAPINZAS TIPO ER DE DOBLE CONTACTO
ЦАНГОВЫЙ ПАТРОН ER С ДВОЙНЫМ КОНТАКТОМ

MANDRINI PORTAPINZA A DOPPIO CONTATTO TIPO ER
MADRINS DOUBLE CONTACT PORTE-PINCE ER
ER双向夹头

DIN 69871 AD

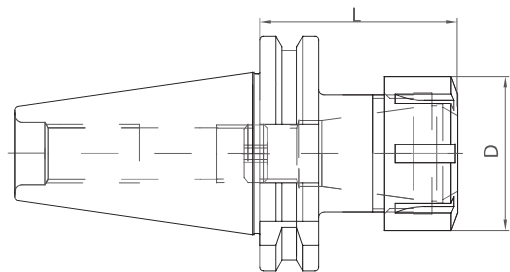
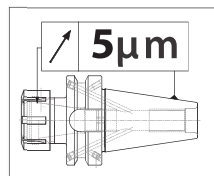

ER	NUT
	
16	812-203080
20	812-203081
25	812-203082
32	812-203083
40	812-203084

Code N.	DESCRIPTION	ISO	ER	D	L	G2,5 30000 RPM
214-37101	TC40H70ER16 AD	40	16	32	70	•
214-37102	TC40H70ER25 AD	40	25	42	70	•
214-37103	TC40H70ER32 AD	40	32	50	70	•
214-37104	TC40H70ER40 AD	40	40	63	70	•
214-37105	TC40H100ER16 AD	40	16	32	100	•
214-37106	TC40H100ER25 AD	40	25	42	100	•
214-37107	TC40H100ER32 AD	40	32	50	100	•
214-37108	TC40H100ER40 AD	40	40	63	100	•
214-37109	TC50H70ER32 AD	50	32	50	70	•
214-37110	TC50H80ER40 AD	50	40	63	80	•

ER COLLET CHUCK

SPANNZANGENFUTTER ER TYP MANDRINI PORTAPINZA TIPO ER
 CONOS PORTAPINZAS TIPO ER MANDRINS A PINCES TYPE ER
 ЦАНГОВЫЕ ПАТРОНЫ ER ER 弹簧夹头

DIN69871 AD+B - DIN 6499

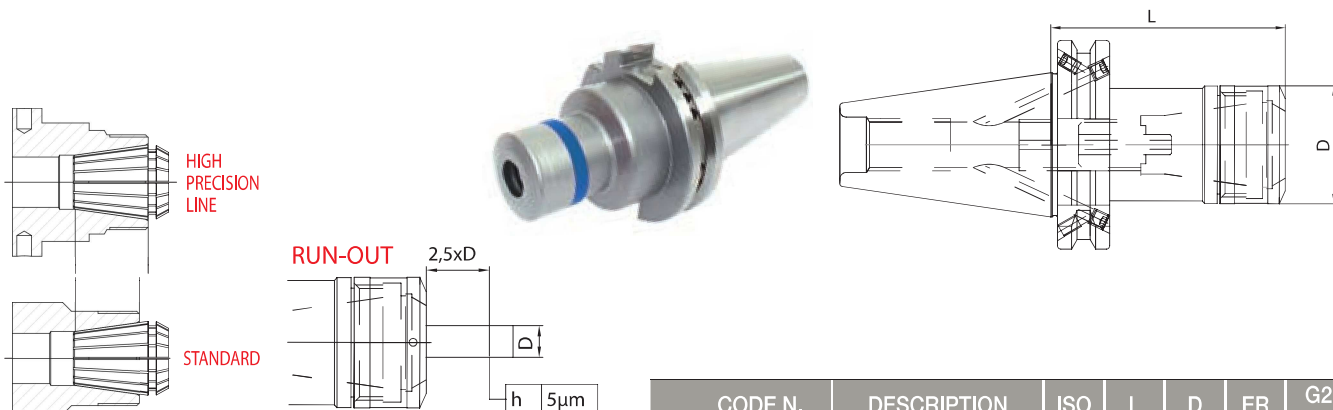

	CODE N.	DESCRIPTION	ISO	L	D	ER	G2,5 30000
ISO 40	214-91355	TC40H70ER16-HP	40	70	30	16	•
	214-91356	TC40H70ER25-HP	40	70	40	25	•
	214-91357	TC40H70ER32-HP	40	70	50	32	•
ISO 50	214-91358	TC50H70ER16-HP	50	70	30	16	•
	214-91366	TC50H70ER25-HP	50	70	40	25	•
	214-91359	TC50H70ER32-HP	50	70	50	32	•
ISO 40	214-91360	TC40H100ER16-HP	40	100	30	16	•
	214-91362	TC40H100ER25-HP	40	100	40	25	•
	214-91363	TC40H100ER32-HP	40	100	50	32	•
ISO 50	214-91364	TC50H100ER16-HP	50	100	30	16	•
	214-91367	TC50H100ER25-HP	50	100	40	25	•
	214-91365	TC50H100ER32-HP	50	100	50	32	•

WRENCHES FOR NUT

SPANNSCHLÜSSEL FÜR SPANNMUTTER CHIAVI PER GHIERA
 LLAVES PARA TUERCA CLES DE SERRAGE POUR ECROU
 КЛЮЧИ ДЛЯ СТАНДАРТНЫХ ГАЕК 标准螺母用扳手

CODE N.	D	D1	ER
816-203069	30	3	16
816-203070	40	4	25
816-203071	50	4	32



COLLETS ER TYPE

ER TYP SPANNZANGEN PINZE TIPO ER
 PINZAS TIPO ER PINCES TYPE ER
 НАБОРЫ ЦАНГ ER ER 类型的夹头

CODE N.	D	L	ER
812-203085	30	18	16
812-203086	40	20,5	25
812-203087	50	23,5	32

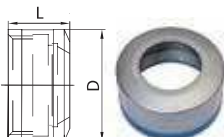

Accessories
 Accessori
 Zubehör
 Accesorios
 Accessoires
 Принадлежности
 零件



pag. 178



pag. 178

COLLET CHUCK KITS

SPANNFUTTERSATZ KIT PORTAPINZE
 SET PORTAPINZAS JEUX PORTE-PINCES
 НАБОРЫ ОПРАВОК С ЦАНГАМИ 夹头变径套组套



Kit Box: 1 Collet chuck + 10 Collets
Cassetta Corredo: 1 Portapinze + 10 pinze
Ausstattungskasten: 1 Spannanzangenfutter + 10 Spannanzangen
Contenido del set: 1 Cono portapinzas + 10 pinzas

Boite d'équipement: 1 Porte-pince + 10 pinces
Набор: из цангового патрона и цанг
套装: 1个弹簧夹头刀柄+ 10个夹头

CODICE ORDINAZIONE ORDER CODE	COMPOSIZIONE COMPOSITION
KIT TC40 ER16 HP	N°1 TC40 H70 ER16 HP + N°10 COLLETS ER16 HP
KIT TC40 ER25 HP	N°1 TC40 H70 ER25 HP + N°10 COLLETS ER25 HP
KIT TC40 ER32 HP	N°1 TC40 H70 ER32 HP + N°10 COLLETS ER32 HP
KIT BT40 ER16 HP	N°1 BT40 H70 ER16 HP + N°10 COLLETS ER16 HP
KIT BT40 ER25 HP	N°1 BT40 H70 ER25 HP + N°10 COLLETS ER25 HP
KIT BT40 ER32 HP	N°1 BT40 H70 ER32 HP + N°10 COLLETS ER32 HP
KIT HSK63 ER16 HP	N°1 HSK63 AH75 ER16 HP + N°10 COLLETS ER16 HP
KIT HSK63 ER25 HP	N°1 HSK63 AH75 ER25 HP + N°10 COLLETS ER25 HP
KIT HSK63 ER32 HP	N°1 HSK63 AH75 ER32 HP + N°10 COLLETS ER32 HP

ER COLLET CHUCK

SPANNZANGENFUTTER ER TYP MANDRINI PORTAPINZA TIPO ER
 CONOS PORTAPINZAS TIPO ER MANDRINS A PINCES TYPE ER
 ЦАНГОВЫЕ ПАТРОНЫ ER ER 弹簧夹头

DIN 69871 AD - DIN6499/ISO15488

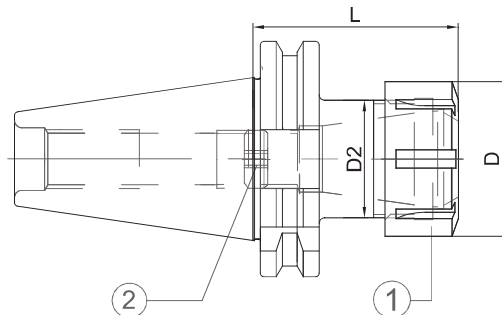
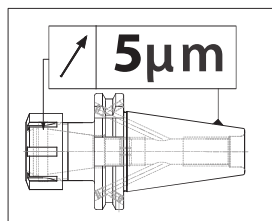



	CODE N.	DESCRIPTION	ISO	ER	D	D2	L	G2,5 30000 RPM
STANDARD	214-91301	TC40H70ER16	40	16	32	22	70	•
	214-91324	TC40H70ER20	40	20	35	25	70	•
	214-91302	TC40H70ER25	40	25	42	32	70	•
	214-91303	TC40H70ER32	40	32	50	40	70	•
	214-91304	TC40H70ER40	40	40	63	50	70	•
	214-91306	TC50H70ER32	50	32	50	40	70	•
	214-91307	TC50H80ER40	50	40	63	50	80	•

	CODE N.	DESCRIPTION	ISO	ER	D	D2	L	G2,5 30000 RPM
H 100	214-91308	TC40H100ER16	40	16	32	31.5	100	•
	214-91325	TC40H100ER20	40	20	35	34.5	100	•
	214-91309	TC40H100ER25	40	25	42	41.5	100	•
	214-91310	TC40H100ER32	40	32	50	49.5	100	•
	214-91311	TC40H100ER40	40	40	63	50	100	•
	214-91312	TC50H100ER16	50	16	32	31.5	100	•
	214-91313	TC50H100ER25	50	25	42	41.5	100	•
	214-91314	TC50H100ER32	50	32	50	49.5	100	•
214-91315	TC50H100ER40	50	40	63	62.5	100	•	

	CODE N.	DESCRIPTION	ISO	ER	D	D2	L	G2,5 30000 RPM
H 160	214-91316	TC40H160ER16	40	16	32	31.5	160	•
	214-91317	TC40H160ER25	40	25	42	41.5	160	•
	214-91318	TC40H160ER32	40	32	50	49.5	160	•
	214-91319	TC40H160ER40	40	40	63	50	160	•

HIGH BALANCED

Spare parts • Componenti
 Ersatzteile • Piezas de repuesto
 Pièces détachées
 Запасные части • 零件

ER	NUT	STOP SCREW
		
16	812-203080	811-303119
20	812-203081	811-303120
25	812-203082	811-303121
32	812-203083	811-303118
40	812-203084	811-303122



ER MINI COLLET CHUCK

SPANNZANGENFUTTER ER MINI MANDRINI PORTAPINZA TIPO ER MINI EXTRA SOTTILI
 CONOS PORTAPINZAS TIPO ER MINI MANDRINS A PINCES TYPE ER MINI
 ЦАНГОВЫЕ МИНИ-ПАТРОНЫ ER ER 迷你弹簧夹头

DIN 69871 AD - DIN6499/ISO15488

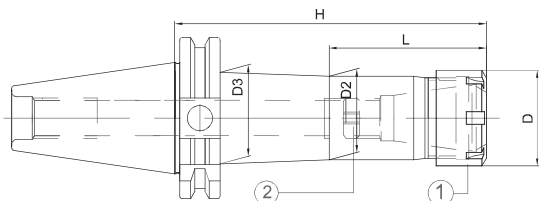

SLIM LINE

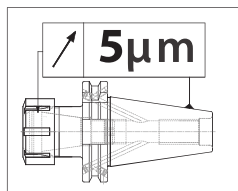

Spare parts • Componenti
 Ersatzteile • Piezas de repuesto
 Pièces détachées
 Запасные части • 零件

CODE N.	DESCRIPTION	ISO	ER	D	H	L	D2	D3	G6,3 15000 RPM
214-91333	TC40H70ER11M	40	11M	16	70	22	14	20	•
214-91334	TC40H100ER11M	40	11M	16	100	40	14	20	•
214-91335	TC40H160ER11M	40	11M	16	160	50	14	27	•
214-91336	TC40H70ER16M	40	16M	22	70	27	20	25	•
214-91337	TC40H100ER16M	40	16M	22	100	47	20	26	•
214-91338	TC40H160ER16M	40	16M	22	160	97	20	26	•
214-91348	TC40H70ER20M	40	20M	28	70	-	26	-	•
214-91349	TC40H100ER20M	40	20M	28	100	48	26	30	•
214-91350	TC40H160ER20M	40	20M	28	160	98	26	31	•
214-91339	TC40H70ER25M	40	25M	35	70	-	33	-	•
214-91340	TC40H100ER25M	40	25M	35	100	-	33	-	•
214-91341	TC40H160ER25M	40	25M	35	160	103	33	33	•
214-91344	TC50H100ER16M	50	16M	22	100	47	22	26	•
214-91344	TC50H160ER16M	50	16M	22	160	97	22	28	•
214-91352	TC50H100ER20M	50	20M	28	100	48	28	32	•
214-91353	TC50H160ER20M	50	20M	28	160	98	28	32	•
214-91346	TC50H100ER25M	50	25M	35	100	-	35	-	•
214-91347	TC50H160ER25M	50	25M	35	160	103	35	40	•

ER	NUT	STOP SCREW
11M	812-203012	811-303081
16M	812-203013	811-303119
20M	812-203014	811-303120
25M	812-203015	811-303121

Accessories
 Accessori
 Zubehör
 Accesorios
 Accessoires
 Принадлежности
 零件



COLLET CHUCK KITS

SPANNFUTTERSATZ KIT PORTAPINZE
 SET PORTAPINZAS JEUX PORTE-PINCES
 НАБОРЫ ОПРАВОК С ЦАНГАМИ 夹头变径套组套

DIN6499/ISO15488

- Kit Box:** 1 Collet chuck + 10 Collets + Wrench
Cassetta Corredo: 1 Portapinze + 10 pinze + chiave
Contenido del set: 1 Cono portapinzas + 10 pinzas + Llave
Ausstattungskasten: 1 Spannzangenfutter + 10 Spannzangen + Spannschlüssel
Boite d'équipement: 1 Porte-pince + 10 pinces + Clé de serrage
Набор: из цангового патрона и цанг
 套装: 1个弹簧夹刀柄 + 10个夹头 + 扳手



	CODE DIN 69871	CODE MAS 403 BT	DESCRIZIONE - DESCRIPTION
ISO 30	KIT TC30ER25	KIT BT30ER25	N°1 portapinze + 10 pinze ER25 + chiave N°1 collet chuck + 10 collets ER25 + wrench (ER25 Ø 2-3-4-5-6-8-10-12-14-16)
	KIT TC30ER32	KIT BT30ER32	N°1 portapinze + 10 pinze ER32 + chiave N°1 collet chuck + 10 collets ER32 + wrench (ER32 Ø 3-4-6-8-10-12-14-16-18-20)
ISO 40	KIT TC40ER25	KIT BT40ER25	N°1 portapinze + 10 pinze ER25 + chiave N°1 collet chuck + 10 collets ER25 + wrench (ER25 Ø 2-3-4-5-6-8-10-12-14-16)
	KIT TC40ER32	KIT BT40ER32	N°1 portapinze + 10 pinze ER32 + chiave N°1 collet chuck + 10 collets ER32 + wrench (ER32 Ø 3-4-6-8-10-12-14-16-18-20)
	KIT TC40ER40	KIT BT40ER40	N°1 portapinze + 10 pinze ER40 + chiave N°1 collet chuck + 10 collets ER40 + wrench (ER40 Ø 5-6-8-10-12-16-20-22-24-26)
ISO 50	KIT TC50ER25	KIT BT50ER25	N°1 portapinze + 10 pinze ER25 + chiave N°1 collet chuck + 10 collets ER25 + wrench (ER25 Ø 2-3-4-5-6-8-10-12-14-16)
	KIT TC50ER32	KIT BT50ER32	N°1 portapinze + 10 pinze ER32 + chiave N°1 collet chuck + 10 collets ER32 + wrench (ER32 Ø 3-4-6-8-10-12-14-16-18-20)
	KIT TC50ER40	KIT BT50ER40	N°1 portapinze + 10 pinze ER40 + chiave N°1 collet chuck + 10 collets ER40 + wrench (ER40 Ø 5-6-8-10-12-16-20-22-24-26)

ER COLLET CHUCK

SPANNZANGENFUTTER ER TYP MANDRINI PORTAPINZA TIPO ER
 CONOS PORTAPINZAS TIPO ER MANDRINS A PINCES TYPE ER
 ЦАНГОВЫЕ ПАТРОНЫ ER ER 弹簧夹头

DIN 69871 AD - DIN6499/ISO15488

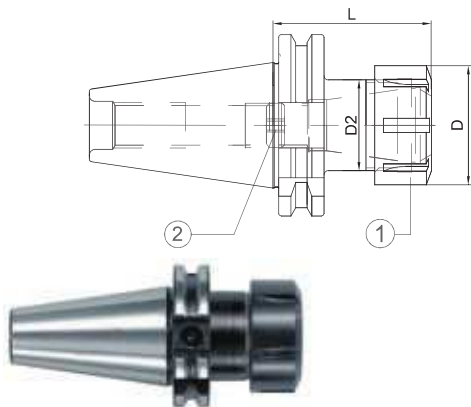

	CODE N.	DESCRIPTION	ISO	ER	D	D2	L	G6,3 15000 RPM
STANDARD	214-31211	TC30H55ER16	30	16	32	22	55	•
	264-31236	TC30H55ER20	30	20	35	25	55	•
	214-31212	TC30H55ER25	30	25	42	32	55	•
	214-31228	TC30H60ER32	30	32	50	40	60	•
	214-31241	TC40H70ER16	40	16	32	22	70	•
	214-31238	TC40H70ER20	40	20	35	25	70	•
	214-31201	TC40H70ER25	40	25	42	32	70	•
	214-31202	TC40H70ER32	40	32	50	40	70	•
	214-31215	TC40H70ER40	40	40	63	50	70	•
	264-31233	TC50H70ER16	50	16	32	22	70	•
	264-31234	TC50H70ER20	50	20	35	25	70	•
	214-31250	TC50H70ER25	50	25	42	32	70	•
	214-31203	TC50H70ER32	50	32	50	40	70	•
	214-31204	TC50H80ER40	50	40	63	50	80	•

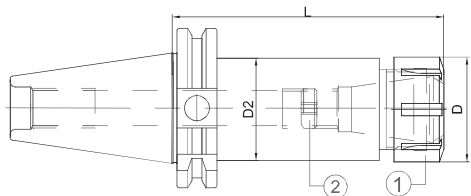

	CODE N.	DESCRIPTION	ISO	ER	D	D2	L	G6,3 15000 RPM	G6,3 8000 RPM
H 100	214-31242	TC40H100ER16	40	16	32	31.5	100	•	
	214-31257	TC40H100ER20	40	20	35	34.5	100	•	
	214-31232	TC40H100ER25	40	25	42	41.5	100	•	
	214-31230	TC40H100ER32	40	32	50	49.5	100	•	
	214-31286	TC40H100ER40	40	40	63	50	100	•	
	214-31365	TC50H100ER16	50	16	32	31.5	100	•	
	214-31380	TC50H100ER20	50	20	35	34.5	100	•	
	214-31342	TC50H100ER25	50	25	42	41.5	100	•	
	214-31336	TC50H100ER32	50	32	50	49.5	100	•	
	214-31339	TC50H100ER40	50	40	63	62.5	100	•	

H 130	214-31385	TC40H130ER16	40	16	32	31.5	130	•	
	214-31386	TC40H130ER20	40	20	35	34.5	130	•	
	214-31387	TC40H130ER25	40	25	42	41.5	130	•	
	214-31389	TC40H130ER32	40	32	50	49.5	130	•	
	214-31390	TC40H130ER40	40	40	63	50	130	•	

H 160	214-31359	TC40H160ER16	40	16	32	31.5	160	•	
	214-31345	TC40H160ER25	40	25	42	41.5	160	•	
	214-31346	TC40H160ER32	40	32	50	49.5	160	•	
	214-31366	TC40H160ER40	40	40	63	50	160	•	
	214-31367	TC50H160ER16	50	16	32	31.5	160	•	
	214-31368	TC50H160ER25	50	25	42	41.5	160	•	
	214-31337	TC50H160ER32	50	32	50	49.5	160	•	
214-31340	TC50H160ER40	50	40	63	62.5	160	•		

H 200	214-31369	TC40H200ER16	40	16	32	31.5	200	•	
	214-31370	TC40H200ER25	40	25	42	41.5	200	•	
	214-31371	TC40H200ER32	40	32	50	49.5	200	•	
	214-31372	TC40H200ER40	40	40	63	50	200	•	
	214-31373	TC50H200ER16	50	16	32	31.5	200	•	
	214-31374	TC50H200ER25	50	25	42	41.5	200	•	
	214-31375	TC50H200ER32	50	32	50	49.5	200	•	
	214-31376	TC50H200ER40	50	40	63	62.5	200	•	

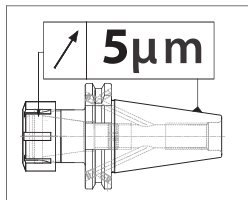

Accessories
 Accessori
 Zubehör
 Accesorios
 Accessoires
 Принадлежности
 零件



ER	NUT	STOP SCREW
16	812-203005	811-303119
20	812-203006	811-303120
25	812-203001	811-303121
32	812-203002	811-303118
40	812-203003	811-303122

Spare parts • Componenti
 Ersatzteile • Piezas de repuesto
 Pièces détachées
 Запасные части • 零件



ER COLLET CHUCK

SPANNZANGENFUTTER ER TYP MANDRINI PORTAPINZA TIPO ER
 CONOS PORTAPINZAS TIPO ER MANDRINS A PINCES TYPE ER
 ЦАНГОВЫЕ ПАТРОНЫ ER ER 弹簧夹头

DIN 69871 AD/B - DIN6499/ISO15488

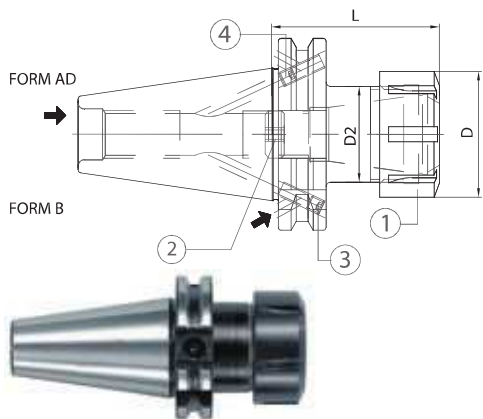

VERSION ON ENQUIRY
 VERSIONE A RICHIESTA

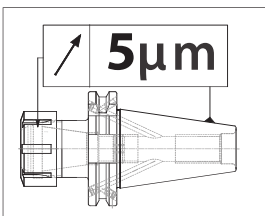





CODE N.	DESCRIPTION	ISO	ER	D	D2	L	G6,3 15000 RPM
214-31362	TC40H70ER16 AD+B	40	16	32	22	70	•
214-31383	TC40H70ER20 AD+B	40	20	35	25	70	•
214-31329	TC40H70ER25 AD+B	40	25	42	32	70	•
214-31331	TC40H70ER32 AD+B	40	32	50	40	70	•
214-31333	TC40H70ER40 AD+B	40	40	63	50	70	•
214-31381	TC50H70ER16 AD+B	50	16	32	22	70	•
214-31382	TC50H70ER20 AD+B	50	20	35	25	70	•
214-31341	TC50H70ER25 AD+B	50	25	42	32	70	•
214-31335	TC50H70ER32 AD+B	50	32	50	40	70	•
214-31338	TC50H80ER40 AD+B	50	40	63	50	80	•

CODE N.	DESCRIPTION	ISO	ER	D	D2	L	G6,3 15000 RPM
214-31363	TC40H100ER16 AD+B	40	16	32	31.5	100	•
214-31384	TC40H100ER20 AD+B	40	20	35	34.5	100	•
214-31347	TC40H100ER25 AD+B	40	25	42	41.5	100	•
214-31348	TC40H100ER32 AD+B	40	32	50	49.5	100	•
214-31364	TC40H100ER40 AD+B	40	40	63	50	100	•

Accessories
 Accessori
 Zubehör
 Accesorios
 Accessoires
 Принадлежности
 零件



Spare parts • Componenti • Ersatzteile • Pièces détachées • Запасные части • 零件

TAPE	SCREW	QUANT.	SCREW	QUANT.	ER	NUT	STOP SCREW
							
ISO 40	811-102002 M4X5	2	811-102002 M4X5	2	16	812-203005	811-303119
ISO 50	811-102001 M4X4	2	811-102010 M5X6	2	20	812-203006	811-303120
					25	812-203001	811-303121
					32	812-203002	811-303118
					40	812-203003	811-303122

ER COLLET CHUCK

SPANNZANGENFUTTER ER TYP MANDRINI PORTAPINZA TIPO ER
 CONOS PORTAPINZAS TIPO ER MANDRINS A PINCES TYPE ER
 ЦАНГОВЫЙ ПАТРОН ДЛЯ ЦАНГ ER ER筒夹头

DIN 69871 AD - DIN6499/ISO15488

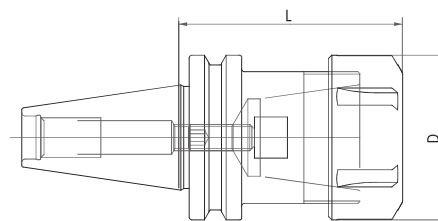
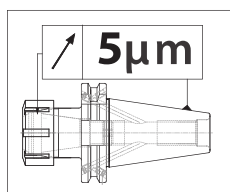

Accessories
 Accessori
 Zubehör
 Accesorios
 Accessoires
 Принадлежности
 零件



CODE N.	DESCRIPTION	TEK	ER	D	L	G2,5 30000
264-31237	TEK30H59ER16M	30	16M	22	59	•
264-31240	TEK30H65ER25	30	25	42	65	•
264-31238	TEK30H50ER32	30	32	50	50	•
264-31239	TEK30H68ER32	30	32	50	68	•

COLLET CHUCKS WITH ER NUT HEXAGONAL TYPE

SPANNZANGENFUTTER MIT ER SECHSKANTMUTTER TYP
CONOS PORTAPINZAS CON TUERCA ER DE TIPO HEXAGONAL
ЦАНГОВЫЕ ПАТРОНЫ ER С ШЕСТИГРАННОЙ ГАЙКОЙ

MANDRINI PORTAPINZA CON GHIERA ER TIPO ESAGONALE
MANDRINS A PINCES AVEC ÉCROU ER TYPE HEXAGONAL
带多边形压帽的ER弹簧夹头

DIN 69871 AD - DIN6499/ISO15488

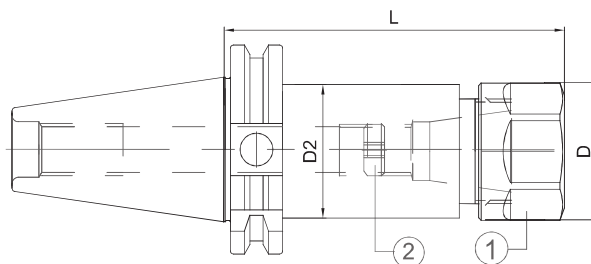
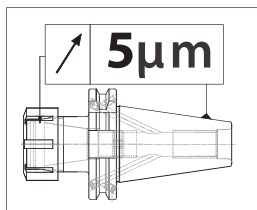

Spare parts • Componenti
Ersatzteile • Piezas de repuesto • Pièces détachées
Запасные части • 零件

CODE N.	DESCRIPTION	ISO	ER	D	L	D2	G6,3 15000 RPM
214-31241EXA	TC40H70EXA16 AD	40	16	28	70	22	•
214-31242EXA	TC40H100EXA16 AD	40	16	28	100	31.5	•
214-31359EXA	TC40H160EXA16 AD	40	16	28	160	31.5	•

ER	NUT	STOP SCREW
16	812-203009	811-303119

ER COLLET CHUCK

SPANNZANGENFUTTER EOC TYP MANDRINI PORTAPINZA TIPO EOC
CONOS PORTAPINZAS TIPO OZ MANDRINS A PINCES TYPE EOC
ЦАНГОВЫЕ ПАТРОНЫ EOC ER 弹簧夹头

DIN 69871 AD - DIN 6388

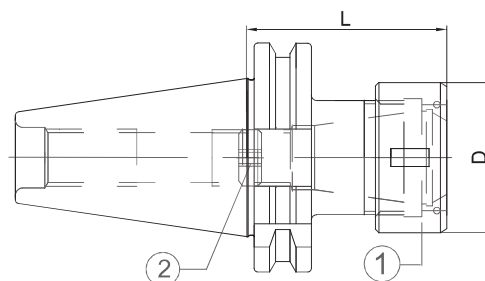
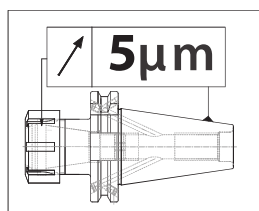

CODE N.	DESCRIPTION	ISO	EOC	D	L	G6,3 12000 RPM
214-11321	TC40H70EOC25	40	25	60	70	•
214-11228	TC40H80EOC32	40	32	60	70	•
214-11323	TC50H80EOC32	50	32	72	80	•

Spare parts • Componenti • Ersatzteile • Piezas de repuesto
Pièces détachées • Запасные части • 零件

EOC	NUT	STOP SCREW	WRENCH
16	GOC16	811-303121	816-203033
25	GOC25	811-303123	816-203034
32	GOC32	811-303123	816-203036

Accessories
Accessori
Zubehör
Accesorios
Accessoires
Принадлежности
零件



pag. 185

pag. 176

ER COLLET CHUCK WITH INSIDE NUT

SPANNZANGENFUTTER ER TYP-LÄNGE EXTRAKURZ MANDRINI PORTAPINZA TIPO ER EXTRACORTI
 CONOS PORTAPINZAS TIPO ER EXTRA-CORTOS MANDRINS COURTS A PINCES TYPE ER
 ЦАНГОВЫЕ ПАТРОНЫ ER С ВНУТРЕННЕЙ ГАЙКОЙ ER 弹簧夹头带内部螺母

DIN 69871 AD - DIN 69871 A

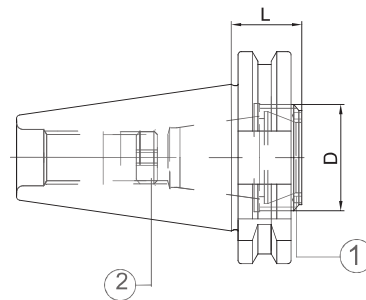
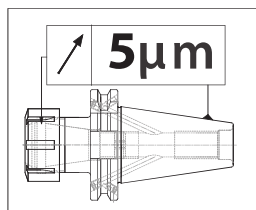

CODE N.	DESCRIPTION	ISO	ER	D	L	G6,3 15000 RPM
214-31377	TC40H21ER25A	40	25	32	21	•
264-31215	TC40H21ER32A	40	32	40	21	•
214-31378	TC50H21ER32A	50	32	40	21	•

Spare parts • Componenti • Ersatzteile • Piezas de repuesto
 Pièces détachées • Запасные части • 零件

ER	NUT	STOP SCREW	WRENCH
25A	812-203057	811-303121	CHER25EX
32A	812-203032	811-303118	CHER32EX

ARBORS FOR DRILL CHUCKS

BOHRFUTTERAUFNAHMEN ATTACCO PER MANDRINI PORTAPUNTE
 CONOS PARA PORTABROCAS CON ESPIGA ARBRES POUR MANDRINS DE PERCAGE
 ОПРАВКИ ДЛЯ СВЕРЛИЛЬНЫХ ПАТРОНОВ 钻夹头刀杆

DIN 69871 AD - DIN 238

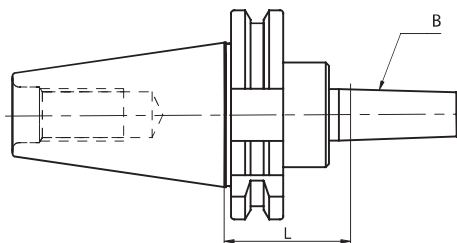

CODE N.	DESCRIPTION	ISO	B	L	G6,3 8000 RPM
216-31201	TC40H40B16	40	16	40	•
216-31202	TC40H40B18	40	18	40	•
216-31203	TC50H40B16	50	16	40	•
216-31204	TC50H40B18	50	18	40	•

ER COLLET CHUCK

SPANNZANGENFUTTER ER TYP MANDRINI PORTAPINZA TIPO ER
 CONOS PORTAPINZAS TIPO ER MANDRINS A PINCES TYPE ER
 ЦАНГОВЫЕ ПАТРОНЫ ER ER 弹簧夹头

MAS BT AD+B - DIN 6499

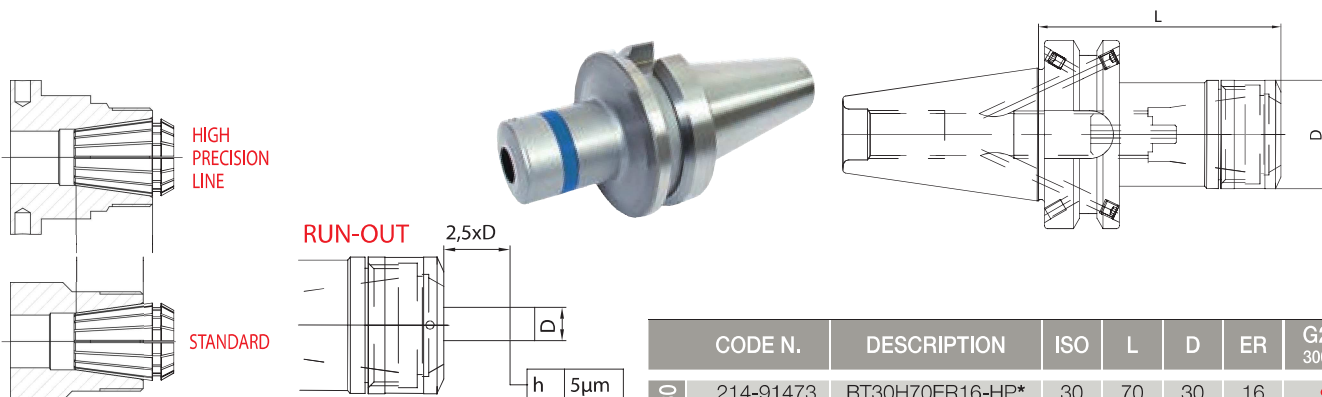

COLLETS ER TYPE
 ER TYP SPANNZANGEN PINZAS TIPO ER
 PINZAS TIPO ER PINCES TYPE ER
 НАБОРЫ ЦАНГ ER ER 类型的夹头

CODE N.	D	L	ER
812-203085	30	18	16
812-203086	40	20,5	25
812-203087	50	23,5	32

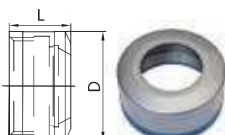

	CODE N.	DESCRIPTION	ISO	L	D	ER	G2,5 30000
ISO 30	214-91473	BT30H70ER16-HP*	30	70	30	16	•
	214-91474	BT30H70ER25-HP*	30	70	40	25	•
	214-91475	BT30H70ER32-HP*	30	70	50	32	•
ISO 40	214-91462	BT40H70ER16-HP	40	70	30	16	•
	214-91463	BT40H70ER25-HP	40	70	40	25	•
	214-91464	BT40H70ER32-HP	40	70	50	32	•
ISO 50	214-91465	BT50H80ER16-HP	50	80	30	16	•
	214-91476	BT50H80ER25-HP	50	80	40	25	•
	214-91466	BT50H80ER32-HP	50	80	50	32	•
ISO 40	214-91467	BT40H100ER16-HP	40	100	30	16	•
	214-91469	BT40H100ER25-HP	40	100	40	25	•
	214-91470	BT40H100ER32-HP	40	100	50	32	•
ISO 50	214-91471	BT50H100ER16-HP	50	100	30	16	•
	214-91477	BT50H100ER25-HP	50	100	40	25	•
	214-91472	BT50H100ER32-HP	50	100	50	32	•

WRENCHES FOR NUT

SPANNSCHLÜSSEL FÜR SPANNMUTTER CHIAVI PER GHIERA
 LLAVES PARA TUERCA CLES DE SERRAGE POUR ECROU
 КЛЮЧИ ДЛЯ СТАНДАРТНЫХ ГАЕК 标准螺母用扳手

CODE N.	D	D1	ER
816-203069	30	3	16
816-203070	40	4	25
816-203071	50	4	32



- * BT30 only AD version
- * BT30 solo versione AD
- * BT30 solo versión AD
- * BT30 nur AD Ausführung
- * BT30 seulement Version AD
- * BT30 только с AD исполнением
- * BT30 只在 AD 版本下



Accessories
 Accessori
 Zubehör
 Accesorios
 Accessoires
 Принадлежности
 零件

COLLET CHUCK KITS

SPANNFUTTERSATZ KIT PORTAPINZES
 SET PORTAPINZAS JEUX PORTE-PINCES
 НАБОРЫ ОПРАВОК С ЦАНГАМИ 夹头变径套组套



- Kit Box:** 1 Collet chuck + 10 Collets
Cassetta Corredo: 1 Portapinzas + 10 pinzas
Contenido del set: 1 Cono portapinzas + 10 pinzas
Ausstattungskasten: 1 Spannanzengenfutter + 10 Spannanzengen

- Boite d'équipement:** 1 Porte-pince + 10 pinces
Набор: из цангового патрона и цанг
 套装: 1个弹簧夹头刀柄 + 10个夹头

CODICE ORDINAZIONE ORDER CODE	COMPOSIZIONE COMPOSITION
KIT TC40 ER16 HP	N°1 TC40 H70 ER16 HP + N°10 COLLETS ER16 HP
KIT TC40 ER25 HP	N°1 TC40 H70 ER25 HP + N°10 COLLETS ER25 HP
KIT TC40 ER32 HP	N°1 TC40 H70 ER32 HP + N°10 COLLETS ER32 HP
KIT BT40 ER16 HP	N°1 BT40 H70 ER16 HP + N°10 COLLETS ER16 HP
KIT BT40 ER25 HP	N°1 BT40 H70 ER25 HP + N°10 COLLETS ER25 HP
KIT BT40 ER32 HP	N°1 BT40 H70 ER32 HP + N°10 COLLETS ER32 HP
KIT HSK63 ER16 HP	N°1 HSK63 AH75 ER16 HP + N°10 COLLETS ER16 HP
KIT HSK63 ER25 HP	N°1 HSK63 AH75 ER25 HP + N°10 COLLETS ER25 HP
KIT HSK63 ER32 HP	N°1 HSK63 AH75 ER32 HP + N°10 COLLETS ER32 HP

ER COLLET CHUCK

SPANNZANGENFUTTER ER TYP MANDRINI PORTAPINZA TIPO ER
 CONOS PORTAPINZAS TIPO ER MANDRINS A PINCES TYPE ER
 ЦАНГОВЫЕ ПАТРОНЫ ER ER 弹簧夹头

JIS-B 6339 MAS 403/BT AD - **DIN6499/ISO15488**

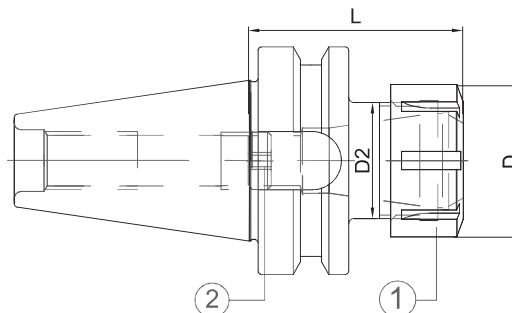
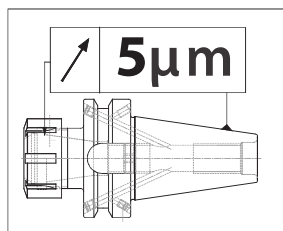



	CODE N.	DESCRIPTION	ISO	ER	D	D2	L	G2,5 30000 RPM
STANDARD	214-91458	BT30H60ER16	30	16	32	22	60	•
	214-91459	BT30H60ER20	30	20	35	25	60	•
	214-91460	BT30H60ER25	30	25	42	32	60	•
	214-91461	BT30H60ER32	30	32	50	40	60	•
	214-91401	BT40H70ER16	40	16	32	22	70	•
	214-91424	BT40H70ER20	40	20	35	25	70	•
	214-91402	BT40H70ER25	40	25	42	32	70	•
	214-91403	BT40H70ER32	40	32	50	40	70	•
	214-91404	BT40H70ER40	40	40	63	50	70	•
	214-91406	BT50H80ER32	50	32	50	40	80	•
214-91407	BT50H80ER40	50	40	63	50	80	•	

	CODE N.	DESCRIPTION	ISO	ER	D	D2	L	G2,5 30000 RPM
H 100	214-91408	BT40H100ER16	40	16	32	31.5	100	•
	214-91425	BT40H100ER20	40	20	35	34.5	100	•
	214-91409	BT40H100ER25	40	25	42	41.5	100	•
	214-91410	BT40H100ER32	40	32	50	49.5	100	•
	214-91411	BT40H100ER40	40	40	63	50	100	•

HIGH BALANCED

Spare parts • Componenti
 Ersatzteile • Piezas de repuesto
 Pièces détachées
 Запасные части • 零件

ER	NUT	STOP SCREW
		
16	812-203080	811-303119
20	812-203081	811-303120
25	812-203082	811-303121
32	812-203083	811-303118
40	812-203084	811-303122



ER MINI COLLET CHUCK

SPANNZANGENFUTTER ER MINI MANDRINI PORTAPINZA TIPO ER MINI EXTRA SOTTILI
 CONOS PORTAPINZAS TIPO ER MINI MANDRINS A PINCES TYPE ER MINI
 ЦАНГОВЫЕ МИНИ-ПАТРОНЫ ER ER 迷你弹簧夹头

JIS-B 6339 MAS 403/BT AD - DIN6499/ISO15488

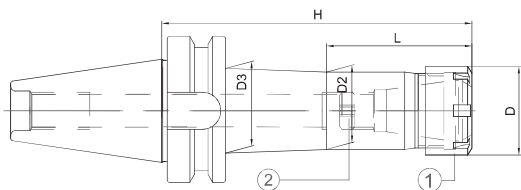

SLIM LINE

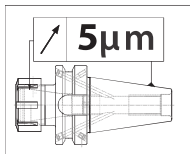

Spare parts • Componenti
 Ersatzteile • Piezas de repuesto
 Pièces détachées
 Запасные части • 零件

CODE N.	DESCRIPTION	ISO	ER	D	H	L	D2	D3	G6,3 15000 RPM
214-91448	BT30H70ER11M	30	11M	16	70	20	14	19	•
214-91449	BT30H100ER11M	30	11M	16	100	20	14	20	•
214-91433	BT40H70ER11M	40	11M	16	70	20	14	20	•
214-91434	BT40H100ER11M	40	11M	16	100	40	14	20	•
214-91435	BT40H160ER11M	40	11M	16	160	50	14	27	•
214-91436	BT40H70ER16M	40	16M	22	70	27	20	25	•
214-91437	BT40H100ER16M	40	16M	22	100	47	20	26	•
214-91438	BT40H160ER16M	40	16M	22	160	97	20	26	•
214-91450	BT40H70ER20M	40	20M	28	70	-	26	-	•
214-91451	BT40H100ER20M	40	20M	28	100	48	26	30	•
214-91452	BT40H160ER20M	40	20M	28	160	98	26	31	•
214-91439	BT40H70ER25M	40	25M	35	70	-	33	-	•
214-91440	BT40H100ER25M	40	25M	35	100	-	33	-	•
214-91441	BT40H160ER25M	40	25M	35	160	103	33	33	•
214-91442	BT50H70ER16M	50	16M	22	70	-	22	-	•
214-91443	BT50H100ER16M	50	16M	22	100	47	22	26	•
214-91444	BT50H160ER16M	50	16M	22	160	97	22	28	•
214-91447	BT50H160ER25M	50	25M	35	160	103	35	40	•

ER	NUT	STOP SCREW
11M	812-203012	811-303081
16M	812-203013	811-303119
20M	812-203014	811-303120
25M	812-203015	811-303121

Accessories
 Accessori
 Zubehör
 Accesorios
 Accessoires
 Принадлежности
 零件



COLLET CHUCK KITS

SPANNFUTTERSATZ KIT PORTAPINZE
 SET PORTAPINZAS JEUX PORTE-PINCES
 НАБОРЫ ОПРАВОК С ЦАНГАМИ 夹头变径套组套

DIN6499/ISO15488

- Kit Box:** 1 Collet chuck + 10 Collets + Wrench
Cassetta Corredo: 1 Portapinze + 10 pinze + chiave
Contenido del set: 1 Cono portapinzas + 10 pinzas + Llave
Ausstattungskasten: 1 Spannzangenfutter + 10 Spannzangen + Spannschlüssel
Boite d'équipement: 1 Porte-pince + 10 pinces + Clé de serrage
Набор: из цангового патрона и цанг
 套装: 1个弹簧夹刀柄 + 10个夹头+扳手



	CODE DIN 69871	CODE MAS 403 BT	DESCRIZIONE - DESCRIPTION
ISO 30	KIT TC30ER25	KIT BT30ER25	N°1 portapinze + 10 pinze ER25 + chiave N°1 collet chuck + 10 collets ER25 + wrench (ER25 Ø 2-3-4-5-6-8-10-12-14-16)
	KIT TC30ER32	KIT BT30ER32	N°1 portapinze + 10 pinze ER32 + chiave N°1 collet chuck + 10 collets ER32 + wrench (ER32 Ø 3-4-6-8-10-12-14-16-18-20)
ISO 40	KIT TC40ER25	KIT BT40ER25	N°1 portapinze + 10 pinze ER25 + chiave N°1 collet chuck + 10 collets ER25 + wrench (ER25 Ø 2-3-4-5-6-8-10-12-14-16)
	KIT TC40ER32	KIT BT40ER32	N°1 portapinze + 10 pinze ER32 + chiave N°1 collet chuck + 10 collets ER32 + wrench (ER32 Ø 3-4-6-8-10-12-14-16-18-20)
	KIT TC40ER40	KIT BT40ER40	N°1 portapinze + 10 pinze ER40 + chiave N°1 collet chuck + 10 collets ER40 + wrench (ER40 Ø 5-6-8-10-12-16-20-22-24-26)
ISO 50	KIT TC50ER25	KIT BT50ER25	N°1 portapinze + 10 pinze ER25 + chiave N°1 collet chuck + 10 collets ER25 + wrench (ER25 Ø 2-3-4-5-6-8-10-12-14-16)
	KIT TC50ER32	KIT BT50ER32	N°1 portapinze + 10 pinze ER32 + chiave N°1 collet chuck + 10 collets ER32 + wrench (ER32 Ø 3-4-6-8-10-12-14-16-18-20)
	KIT TC50ER40	KIT BT50ER40	N°1 portapinze + 10 pinze ER40 + chiave N°1 collet chuck + 10 collets ER40 + wrench (ER40 Ø 5-6-8-10-12-16-20-22-24-26)

ER COLLET CHUCK

SPANNZANGENFUTTER ER TYP MANDRINI PORTAPINZA TIPO ER
 CONOS PORTAPINZAS TIPO ER MANDRINS A PINCES TYPE ER
 ЦАНГОВЫЕ ПАТРОНЫ ER ER 弹簧夹头

JIS-B 6339 MAS 403/BT AD - DIN6499/ISO15488

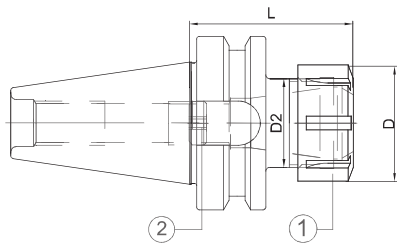

	CODE N.	DESCRIPTION	ISO	ER	D	D2	L	G6,3 15000 RPM
STANDARD	214-31511	BT30H60ER16	30	16	32	22	60	•
	214-31585	BT30H60ER20	30	20	35	25	60	•
	214-31512	BT30H60ER25	30	25	42	32	60	•
	214-31525	BT30H60ER32	30	32	50	40	60	•
	214-31539	BT40H70ER16	40	16	32	22	70	•
	214-31555	BT40H70ER20	40	20	35	25	70	•
	214-31501	BT40H70ER25	40	25	42	32	70	•
	214-31502	BT40H70ER32	40	32	50	40	70	•
	214-31515	BT40H70ER40	40	40	63	50	70	•
	214-31584	BT50H80ER16	50	16	32	22	70	•
	214-31586	BT50H80ER20	50	20	35	25	80	•
	214-31549	BT50H80ER25	50	25	42	32	80	•
214-31503	BT50H80ER32	50	32	50	40	80	•	
214-31504	BT50H80ER40	50	40	63	50	80	•	

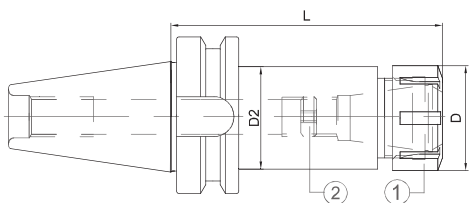

	CODE N.	DESCRIPTION	ISO	ER	D	D2	L	G6,3 15000 RPM	G6,3 8000 RPM
H 100	214-31520	BT30H100ER16	30	16	32	31,5	100	•	
	214-31573	BT30H100ER20	30	20	35	34,5	100	•	
	214-31538	BT30H100ER25	30	25	42	40	100	•	
	214-31527	BT40H100ER16	40	16	32	31,5	100	•	
	214-31556	BT40H100ER20	40	20	35	34,5	100	•	
	214-31542	BT40H100ER25	40	25	42	41,5	100	•	
	214-31545	BT40H100ER32	40	32	50	49,5	100	•	
	214-31583	BT40H100ER40	40	40	63	50	100	•	
	214-31450	BT50H100ER16	50	16	32	31,5	100	•	
	214-31476	BT50H100ER20	50	20	35	34,5	100	•	
	214-31438	BT50H100ER25	50	25	42	41,5	100	•	
	214-31434	BT50H100ER32	50	32	50	49,5	100	•	
214-31436	BT50H100ER40	50	40	63	62,5	100	•		

H 130	214-31477	BT40H130ER16	40	16	32	31,5	130	•	
	214-31478	BT40H130ER20	40	20	35	34,5	130	•	
	214-31479	BT40H130ER25	40	25	42	41,5	130	•	
	214-31480	BT40H130ER32	40	32	50	49,5	130	•	
	214-31481	BT40H130ER40	40	40	63	50	130	•	

H 160	214-31442	BT40H160ER16	40	16	32	31,5	160	•	
	214-31432	BT40H160ER25	40	25	42	41,5	160	•	
	214-31433	BT40H160ER32	40	32	50	49,5	160	•	
	214-31451	BT40H160ER40	40	40	63	50	160	•	
	214-31452	BT50H160ER16	50	16	32	31,5	160	•	
	214-31453	BT50H160ER25	50	25	42	41,5	160	•	
	214-31435	BT50H160ER32	50	32	50	49,5	160	•	
214-31437	BT50H160ER40	50	40	63	62,5	160	•		

H 200	214-31454	BT40H200ER16	40	16	32	31,5	200	•	
	214-31455	BT40H200ER25	40	25	42	41,5	200	•	
	214-31456	BT40H200ER32	40	32	50	49,5	200	•	
	214-31457	BT40H200ER40	40	40	63	50	200	•	
	214-31458	BT50H200ER16	50	16	32	31,5	200	•	
	214-31459	BT50H200ER25	50	25	42	41,5	200	•	
	214-31460	BT50H200ER32	50	32	50	49,5	200	•	
	214-31461	BT50H200ER40	50	40	63	62,5	200	•	

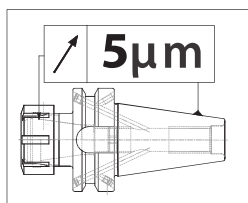

Accessories
 Accessori
 Zubehör
 Accesorios
 Accessoires
 Принадлежности
 零件



pag. 101



pag. 177



pag. 184



pag. 177



pag. 184

ER	NUT	STOP SCREW
16	812-203005	811-303119
20	812-203006	811-303120
25	812-203001	811-303121
32	812-203002	811-303118
40	812-203003	811-303122

Spare parts • Componenti
 Ersatzteile • Piezas de repuesto
 Pièces détachées
 Запасные части • 零件



ER COLLET CHUCK

SPANNZANGENFUTTER ER TYP MANDRINI PORTAPINZA TIPO ER
 CONOS PORTAPINZAS TIPO ER MANDRINS A PINCES TYPE ER
 ЦАНГОВЫЕ ПАТРОНЫ ER 弹簧夹头

JIS-B 6339 MAS 403/BT AD/B DIN6499/ISO15488

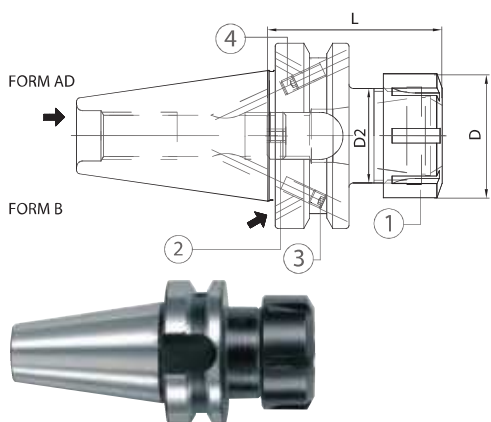



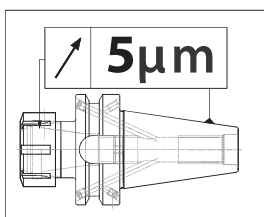

CODE N.	DESCRIPTION	ISO	ER	D	D2	L	G6,3 15000 RPM
214-31447	BT40H70ER16 AD+B	40	16	32	22	70	•
214-31474	BT40H70ER20 AD+B	40	20	35	25	70	•
214-31422	BT40H70ER25 AD+B	40	25	42	32	70	•
214-31423	BT40H70ER32 AD+B	40	32	50	40	70	•
214-31424	BT40H70ER40 AD+B	40	40	63	50	70	•
214-31469	BT50H80ER16 AD+B	50	16	32	22	80	•
214-31470	BT50H80ER20 AD+B	50	20	35	25	80	•
214-31429	BT50H80ER25 AD+B	50	25	42	32	80	•
214-31430	BT50H80ER32 AD+B	50	32	50	40	80	•
214-31431	BT50H80ER40 AD+B	50	40	63	50	80	•

VERSION ON ENQUIRY
 VERSIONE A RICHIESTA

CODE N.	DESCRIPTION	ISO	ER	D	D2	L	G6,3 15000 RPM
214-31448	BT40H100ER16 AD+B	40	16	32	31.5	100	•
214-31475	BT40H100ER20 AD+B	40	20	35	34.5	100	•
214-31439	BT40H100ER25 AD+B	40	25	42	41.5	100	•
214-31440	BT40H100ER32 AD+B	40	32	50	49.5	100	•
214-31449	BT40H100ER40 AD+B	40	40	63	50	100	•



Spare parts • Componenti • Ersatzteile • Piezas de repuesto • Pièces détachées • Запасные части • 零件

TAPE	SCREW	QUANT.	SCREW	QUANT.	ER	NUT	STOP SCREW
							
ISO 40	811-102002 M4X5	2	811-102002 M4X5	2	16	812-203005	811-303119
ISO 50	811-102002 M4X5	2	811-102010 M5X6	2	20	812-203006	811-303120
					25	812-203001	811-303121
					32	812-203002	811-303118
					40	812-203003	811-303122

Accessories
 Accessori
 Zubehör
 Accesorios
 Accessoires
 Принадлежности
 零件



COLLET CHUCKS WITH ER NUT HEXAGONAL TYPE



SPANNZANGENFUTTER MIT ER SECHSKANTMUTTER TYP
CONOS PORTAPINZAS CON TUERCA ER DE TIPO HEXAGONAL
ЦАНГОВЫЕ ПАТРОНЫ ER С ШЕСТИГРАННОЙ ГАЙКОЙ

MANDRINI PORTAPINZA CON GHIERA ER TIPO ESAGONALE
MANDRINS A PINCES AVEC ÉCROU ER TYPE HEXAGONAL
带多边形压帽的ER弹簧夹头

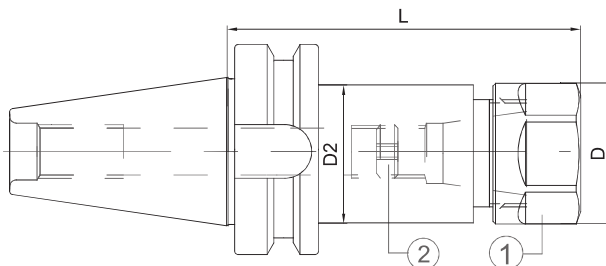
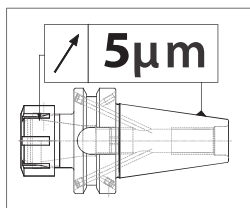
JIS-B 6339 MAS403/BT AD - DIN6499/ISO15488



Spare parts • Componenti • Ersatzteile • Piezas de repuesto
Pièces détachées • Запасные части • 零件

ER	NUT	STOP SCREW
		
16	812-203009	811-303119

CODE N.	DESCRIPTION	ISO	ER	D	L	D2	G6,3 15000 RPM
214-31511EXA	BT30H60EXA16 AD	30	16	28	60	22	•
214-31520EXA	BT30H100EXA16 AD	30	16	28	100	27,5	•
214-31539EXA	BT40H70EXA16 AD	40	16	28	70	22	•
214-31527EXA	BT40H100EXA16 AD	40	16	28	100	27,5	•
214-31442EXA	BT40H160EXA16 AD	40	16	28	160	27,5	•



ER COLLET CHUCK

SPANNZANGENFUTTER EOC TYP MANDRINI PORTAPINZA TIPO EOC
CONOS PORTAPINZAS TIPO OZ MANDRINS A PINCES TYPE EOC
ЦАНГОВЫЕ ПАТРОНЫ EOC ER 弹簧夹头

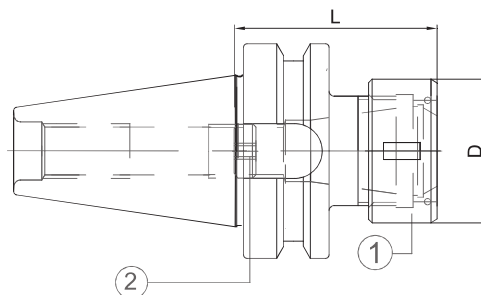
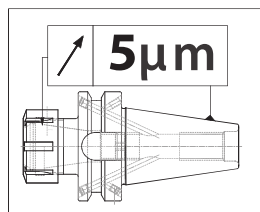
JIS-B 6339 MAS 403/BT AD - DIN 6388



Spare parts • Componenti • Ersatzteile • Piezas de repuesto
Pièces détachées • Запасные части • 零件

EOC	NUT	STOP SCREW	WRENCH
			
16	GOC16	811-303121	816-203033
25	GOC25	811-303123	816-203034
32	GOC32	811-303123	816-203036

CODE N.	DESCRIPTION	ISO	EOC	D	L	G6,3 12000 RPM
214-11402	BT40H70EOC25	40	25	60	70	•
214-11524	BT40H80EOC32	40	32	72	80	•
214-11404	BT50H90EOC32	50	32	72	90	•

Accessories
Accessori
Zubehör
Accesorios
Accessoires
Принадлежности
零件



ER COLLET CHUCK WITH INSIDE NUT

SPANNZANGENFUTTER ER TYP-LÄNGE EXTRAKURZ MANDRINI PORTAPINZA TIPO ER EXTRACORTI
 CONOS PORTAPINZAS TIPO ER EXTRA-CORTOS MANDRINS COURTS A PINCES TYPE ER
 ЦАНГОВЫЕ ПАТРОНЫ ER С ВНУТРЕННЕЙ ГАЙКОЙ ER 弹簧夹头带内部螺母

JIS-B 6339 MAS 403/BT AD - MAS 403/BT A

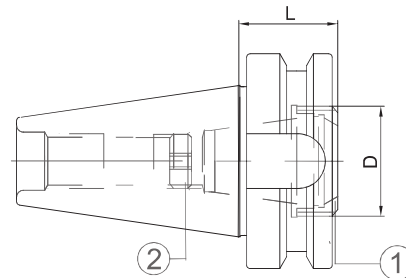
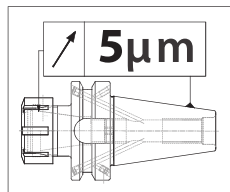

CODE N.	DESCRIPTION	ISO	ER	D	L	G6,3 15000 RPM
214-31462	BT40H29ER25A	40	25	32	29	•
214-31571	BT40H29ER32A	40	32	40	29	•
214-31463	BT50H40ER32A	50	32	40	40	•

Spare parts • Componenti • Ersatzteile • Piezas de repuesto
 Pièces détachées • Запасные части • 零件

ER	NUT	STOP SCREW	WRENCH
25A	812-203057	811-303121	CHER25EX
32A	812-203032	811-303118	CHER32EX

ARBORS FOR DRILL CHUCKS

BOHRFUTTERAUFNAHMEN ATTACCO PER MANDRINI PORTAPUNTE
 CONOS PARA PORTABROCAS CON ESPIGA ARBRES POUR MANDRINS DE PERCAGE
 ОПРАВКИ ДЛЯ СВЕРЛИЛЬНЫХ ПАТРОНОВ 钻夹头刀杆

JIS-B 6339 MAS 403/BT AD - DIN 238

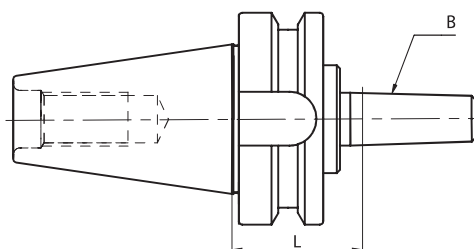

CODE N.	DESCRIPTION	ISO	B	L	G6,3 8000 RPM
216-31502	BT40H40B16	40	16	40	•



ER COLLET CHUCK

SPANNZANGENFUTTER ER TYP MANDRINI PORTAPINZA TIPO ER
 CONOS PORTAPINZAS TIPO ER MANDRINS A PINCES TYPE ER
 ЦАНГОВЫЕ ПАТРОНЫ ER ER 弹簧夹头

DIN 2080 - DIN6499/ISO15488

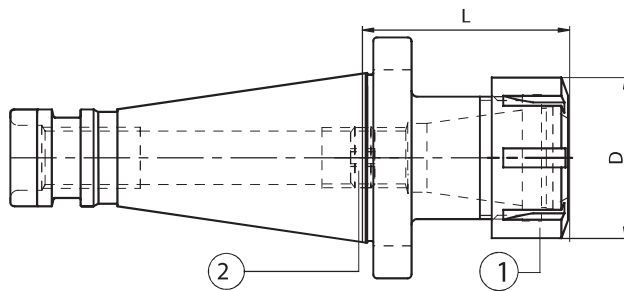
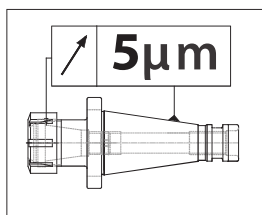

CODE N.	DESCRIPTION	ISO	ER	D	L
214-31105	ISO30H42ER16	30	16	32	42
214-31106	ISO30H42ER25	30	25	42	42
214-31107	ISO30H50ER32	30	32	50	50
214-31152	ISO40H55ER16	40	16	32	55
214-31101	ISO40H53ER25	40	25	42	53
214-31108	ISO40H110ER25	40	25	42	110
214-31102	ISO40H70ER32	40	32	50	70
214-31109	ISO40H110ER32	40	32	50	110
214-31110	ISO50H140ER32	50	32	50	140
214-31114	ISO40H80ER40	40	40	63	80
214-31137	ISO50H65ER25	50	25	42	65
214-31103	ISO50H68ER32	50	32	50	68
214-31104	ISO50H76ER40	50	40	63	76
214-31111	ISO50H140ER40	50	40	63	140

Spare parts • Componenti • Ersatzteile • Piezas de repuesto
 Pièces détachées • Запасные части • 零件

ER	Nut	STOP SCREW	STOP SCREW
16	812-203005	811-303119	-
25	812-203001	811-303121	-
ISO30/25	812-203001	-	811-303001
32	812-203002	811-303118	-
ISO30/32	812-203002	-	811-303001
40	812-203003	811-303122	-

Accessories
 Accessori
 Zubehör
 Accesorios
 Accessoires
 Принадлежности
 零件

pag. 101

pag. 177

pag. 184

pag. 184

pag. 177

