

PROLUNGHE CILINDRICHE PORTAPINZA ER CON GHIERA MINI
CYLINDRICAL SHANK ER COLLET CHUCKS WITH MINI NUT

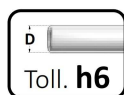

Fig.1

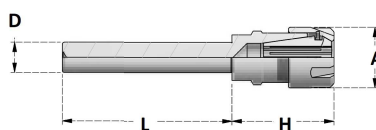
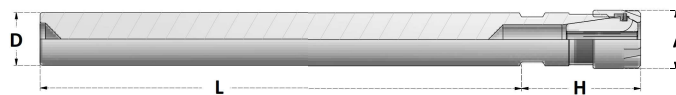

Fig.2



Articolo		D	A	L	H	Collets Range	Ghiera Nut	FIG
D6.L45.ERC8M	*	6	12	45	22,5	1+5	G8M	1
D6.L60.ERC8M	*	6	12	60	22,5	1+5	G8M	1
D6.L80.ERC8M	*	6	12	80	22,5	1+5	G8M	1
D6.L100.ERC8M	*	6	12	100	22,5	1+5	G8M	1
D8.L45.ERC8M	*	8	12	45	22,5	1+5	G8M	1
D8.L60.ERC8M	*	8	12	60	22,5	1+5	G8M	1
D8.L80.ERC8M	*	8	12	80	22,5	1+5	G8M	1
D8.L100.ERC8M	*	8	12	100	22,5	1+5	G8M	1
D8.L130.ERC8M	*	8	12	130	22,5	1+5	G8M	1
D10.L45.ERC8M	*	10	12	45	25,5	1+5	G8M	2
D10.L60.ERC8M	*	10	12	60	25,5	1+5	G8M	2
D10.L80.ERC8M	*	10	12	80	25,5	1+5	G8M	2
D10.L100.ERC8M	*	10	12	100	25,5	1+5	G8M	2
D10.L130.ERC8M	*	10	12	130	25,5	1+5	G8M	2
D10.L160.ERC8M	*	10	12	160	25,5	1+5	G8M	2
D12.L45.ERC8M	*	12	12	45	25,5	1+5	G8M	2
D12.L60.ERC8M	*	12	12	60	25,5	1+5	G8M	2
D12.L80.ERC8M	*	12	12	80	25,5	1+5	G8M	2
D12.L100.ERC8M	*	12	12	100	25,5	1+5	G8M	2
D12.L130.ERC8M	*	12	12	130	25,5	1+5	G8M	2
D12.L160.ERC8M	*	12	12	160	25,5	1+5	G8M	2
D12.L200.ERC8M	*	12	12	200	25,5	1+5	G8M	2

* = SENZA PASSAGGIO DEL REFRIGERANTE

* = WITHOUT COOLANT BORE

KIT - MANDRINO, CHIAVE E PINZE

KIT - TOOLHOLDER, WRENCH AND COLLETS

Articolo	Pinze Collets	Mandrino Chuck	Chiave Wrench
BX.D10.L100.8M	ERC8.D1+5 x 0,5mm	D10.L100.ERC8M	CH8M
BX.D10.L130.8M	ERC8.D1+5 x 0,5mm	D10.L130.ERC8M	CH8M
BX.D10.L160.8M	ERC8.D1+5 x 0,5mm	D10.L160.ERC8M	CH8M
BX.D12.L100.8M	ERC8.D1+5 x 0,5mm	D12.L100.ERC8M	CH8M
BX.D12.L130.8M	ERC8.D1+5 x 0,5mm	D12.L130.ERC8M	CH8M
BX.D12.L160.8M	ERC8.D1+5 x 0,5mm	D12.L160.ERC8M	CH8M

ALTRI A RICHIESTA
OTHERS ON REQUEST



ACCESSORI - ACCESSORIES

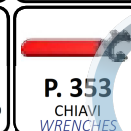
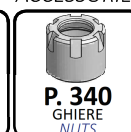

PROLUNGHE CILINDRICHE PORTAPINZA ER CON GHIERA MINI
CYLINDRICAL SHANK ER COLLET CHUCKS WITH MINI NUT

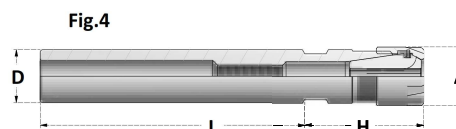
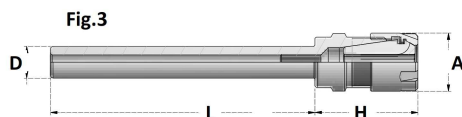
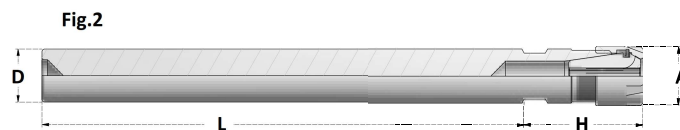
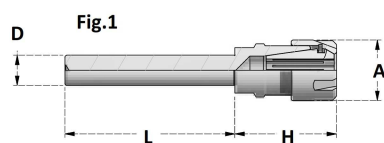

Articolo		D	A	L	H	Collets Range	Ghiera Nut	FIG
D6.L45.ERC11M	*	6	16	45	27	1÷7	G11M	1
D6.L60.ERC11M	*	6	16	60	27	1÷7	G11M	1
D6.L80.ERC11M	*	6	16	80	27	1÷7	G11M	1
D6.L100.ERC11M	*	6	16	100	27	1÷7	G11M	1
D8.L45.ERC11M	*	8	16	45	30	1÷7	G11M	1
D8.L60.ERC11M	*	8	16	60	30	1÷7	G11M	1
D8.L80.ERC11M	*	8	16	80	26	1÷7	G11M	1
D8.L100.ERC11M	*	8	16	100	26	1÷7	G11M	1
D8.L130.ERC11M	*	8	16	130	26	1÷7	G11M	1
D10.L45.ERC11M	*	10	16	45	26	1÷7	G11M	1
D10.L60.ERC11M	*	10	16	60	26	1÷7	G11M	1
D10.L80.ERC11M	*	10	16	80	26	1÷7	G11M	1
D10.L100.ERC11M	*	10	16	100	26	1÷7	G11M	1
D10.L130.ERC11M	*	10	16	130	26	1÷7	G11M	1
D10.L160.ERC11M	*	10	16	160	26	1÷7	G11M	1
D12.L45.ERC11M		12	16	45	26	1÷7	G11M	3
D12.L60.ERC11M		12	16	60	26	1÷7	G11M	3
D12.L80.ERC11M		12	16	80	26	1÷7	G11M	3
D12.L100.ERC11M	*	12	16	100	26	1÷7	G11M	1
D12.L130.ERC11M	*	12	16	130	26	1÷7	G11M	1
D12.L160.ERC11M	*	12	16	160	26	1÷7	G11M	1
D12.L200.ERC11M	*	12	16	200	26	1÷7	G11M	1
D16.L45.ERC11M		16	16	45	33	1÷7	G11M	4
D16.L60.ERC11M		16	16	60	33	1÷7	G11M	4
D16.L80.ERC11M		16	16	80	33	1÷7	G11M	4
D16.L100.ERC11M		16	16	100	33	1÷7	G11M	4
D16.L130.ERC11M		16	16	130	33	1÷7	G11M	4
D16.L160.ERC11M		16	16	160	33	1÷7	G11M	4
D16.L200.ERC11M	*	16	16	200	33	1÷7	G11M	2
D16.L250.ERC11M	*	16	16	250	33	1÷7	G11M	2
D16.L300.ERC11M	*	16	16	300	33	1÷7	G11M	2
D20.L60.ERC11M		20	16	60	35	1÷7	G11M	4
D20.L80.ERC11M		20	16	80	35	1÷7	G11M	4
D20.L100.ERC11M		20	16	100	35	1÷7	G11M	4
D20.L130.ERC11M		20	16	130	35	1÷7	G11M	4
D20.L160.ERC11M		20	16	160	35	1÷7	G11M	4
D20.L200.ERC11M		20	16	200	35	1÷7	G11M	4
D20.L250.ERC11M		20	16	250	35	1÷7	G11M	4
D20.L300.ERC11M	*	20	16	300	35	1÷7	G11M	2

* = SENZA PASSAGGIO DEL REFRIGERANTE

* = WITHOUT COOLANT BORE

ACCESSORI - ACCESSORIES

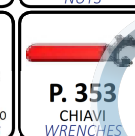
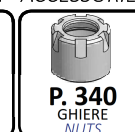

PROLUNGHE CILINDRICHE PORTAPINZA ER CON GHIERA MINI
CYLINDRICAL SHANK ER COLLET CHUCKS WITH MINI NUT

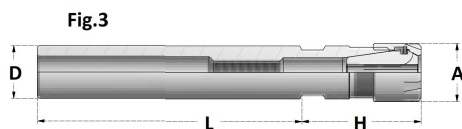
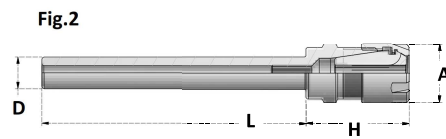
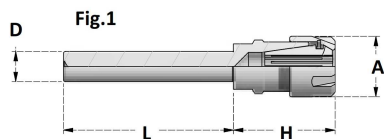

Articolo	D	A	L	H	Collets Range	Ghiera Nut	FIG
D25.L60.ERC11M	25	16	60	35	1÷7	G11M	3
D25.L80.ERC11M	25	16	80	35	1÷7	G11M	3
D25.L100.ERC11M	25	16	100	35	1÷7	G11M	3
D25.L130.ERC11M	25	16	130	35	1÷7	G11M	3
D25.L160.ERC11M	25	16	160	35	1÷7	G11M	3
D25.L200.ERC11M	25	16	200	35	1÷7	G11M	3
D25.L250.ERC11M	25	16	250	35	1÷7	G11M	3
D25.L300.ERC11M	25	16	300	35	1÷7	G11M	3

Articolo	D	A	L	H	Collets Range	Ghiera Nut	FIG
D1/2-L2.36-ERC11M	12,7	16	59,9	26	1÷7	G11M	2
D1/2-L3.93-ERC11M	* 12,7	16	99,8	26	1÷7	G11M	1
D1/2-L5.11-ERC11M	* 12,7	16	129,8	26	1÷7	G11M	1
D1/2-L6.29-ERC11M	* 12,7	16	159,9	26	1÷7	G11M	1
D5/8-L2.36-ERC11M	15,87	16	59,9	33	1÷7	G11M	2
D5/8-L3.93-ERC11M	15,87	16	99,8	33	1÷7	G11M	2
D5/8-L5.11-ERC11M	15,87	16	129,8	33	1÷7	G11M	2
D5/8-L6.29-ERC11M	15,87	16	159,9	33	1÷7	G11M	2
D3/4-L2.36-ERC11M	19,05	16	59,9	35	1÷7	G11M	2
D3/4-L3.93-ERC11M	19,05	16	99,8	35	1÷7	G11M	2
D3/4-L5.11-ERC11M	19,05	16	129,8	35	1÷7	G11M	2
D3/4-L6.29-ERC11M	19,05	16	159,9	35	1÷7	G11M	2

* = SENZA PASSAGGIO DEL REFRIGERANTE

* = WITHOUT COOLANT BORE



KIT - MANDRINO, CHIAVE E PINZE

KIT - TOOLHOLDER, WRENCH AND COLLETS

Articolo	Pinze Collets	Mandrino Chuck	Chiave Wrench
BX.D12.L100.11M	ERC11.D1÷7 x 0,5mm	D12.L100.ERC11M	CH11M
BX.D12.L130.11M	ERC11.D1÷7 x 0,5mm	D12.L130.ERC11M	CH11M
BX.D12.L160.11M	ERC11.D1÷7 x 0,5mm	D12.L160.ERC11M	CH11M
BX.D16.L100.11M	ERC11.D1÷7 x 0,5mm	D16.L100.ERC11M	CH11M
BX.D16.L130.11M	ERC11.D1÷7 x 0,5mm	D16.L130.ERC11M	CH11M
BX.D16.L160.11M	ERC11.D1÷7 x 0,5mm	D16.L160.ERC11M	CH11M

ALTRI A RICHIESTA
OTHERS ON REQUEST

ACCESSORI - ACCESSORIES

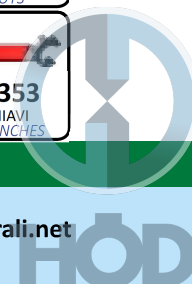
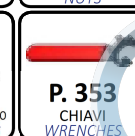
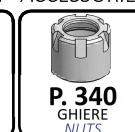

PROLUNGHE CILINDRICHE PORTAPINZA ER CON GHIERA MINI
CYLINDRICAL SHANK ER COLLET CHUCKS WITH MINI NUT

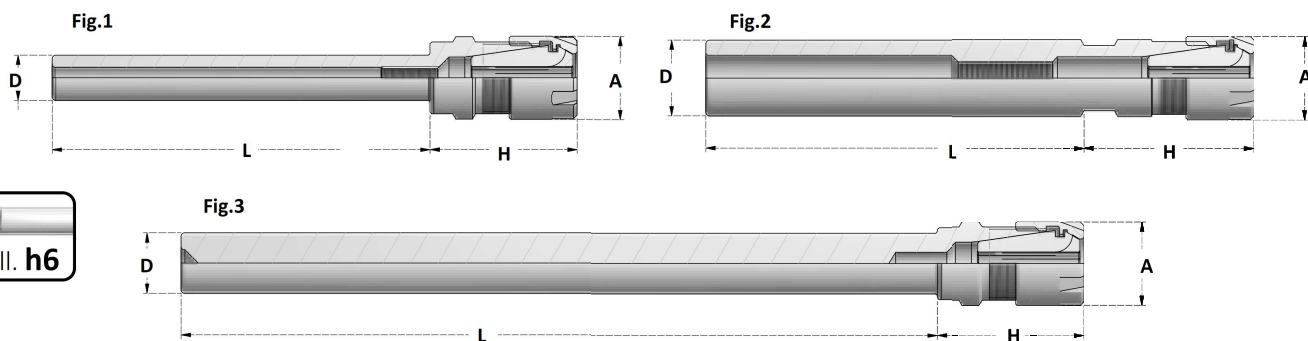

Articolo	D	A	L	H	Collets Range	Ghiera Nut	FIG	
D10.L60.ERC16M	10	22	60	38	1÷10	G16M	1	
D10.L80.ERC16M	10	22	80	38	1÷10	G16M	1	
D10.L100.ERC16M	*	10	22	100	38	1÷10	G16M	3
D10.L130.ERC16M	*	10	22	130	38	1÷10	G16M	3
D10.L160.ERC16M	*	10	22	160	38	1÷10	G16M	3
D12.L60.ERC16M	12	22	60	38	1÷10	G16M	1	
D12.L80.ERC16M	12	22	80	38	1÷10	G16M	1	
D12.L100.ERC16M	12	22	100	38	1÷10	G16M	3	
D12.L130.ERC16M	*	12	22	130	38	1÷10	G16M	3
D12.L160.ERC16M	*	12	22	160	38	1÷10	G16M	3
D12.L200.ERC16M	*	12	22	200	38	1÷10	G16M	3
D16.L60.ERC16M	16	22	60	38	1÷10	G16M	1	
D16.L80.ERC16M	16	22	80	38	1÷10	G16M	1	
D16.L100.ERC16M	16	22	100	38	1÷10	G16M	1	
D16.L130.ERC16M	16	22	130	38	1÷10	G16M	1	
D16.L160.ERC16M	16	22	160	38	1÷10	G16M	1	
D16.L200.ERC16M	*	16	22	200	38	1÷10	G16M	3
D16.L250.ERC16M	*	16	22	250	38	1÷10	G16M	3
D16.L300.ERC16M	*	16	22	300	38	1÷10	G16M	3
D20.L60.ERC16M	20	22	60	40	1÷10	G16M	2	
D20.L80.ERC16M	20	22	80	40	1÷10	G16M	2	
D20.L100.ERC16M	20	22	100	40	1÷10	G16M	2	
D20.L130.ERC16M	20	22	130	40	1÷10	G16M	2	
D20.L160.ERC16M	20	22	160	40	1÷10	G16M	2	
D20.L200.ERC16M	20	22	200	40	1÷10	G16M	2	
D20.L250.ERC16M	20	22	250	40	1÷10	G16M	2	
D20.L300.ERC16M	*	20	22	300	40	1÷10	G16M	3
D25.L60.ERC16M	25	22	60	40	1÷10	G16M	2	
D25.L80.ERC16M	25	22	80	40	1÷10	G16M	2	
D25.L100.ERC16M	25	22	100	40	1÷10	G16M	2	
D25.L130.ERC16M	25	22	130	40	1÷10	G16M	2	
D25.L160.ERC16M	25	22	160	40	1÷10	G16M	2	
D25.L200.ERC16M	25	22	200	40	1÷10	G16M	2	
D25.L250.ERC16M	25	22	250	40	1÷10	G16M	2	
D25.L300.ERC16M	25	22	300	40	1÷10	G16M	2	

* = SENZA PASSAGGIO DEL REFRIGERANTE

* = WITHOUT COOLANT BORE

ACCESSORI - ACCESSORIES

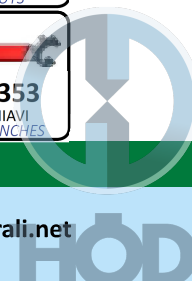
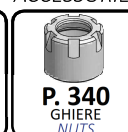

PROLUNGHE CILINDRICHE PORTAPINZA ER CON GHIERA MINI

CYLINDRICAL SHANK ER COLLET CHUCKS WITH MINI NUT

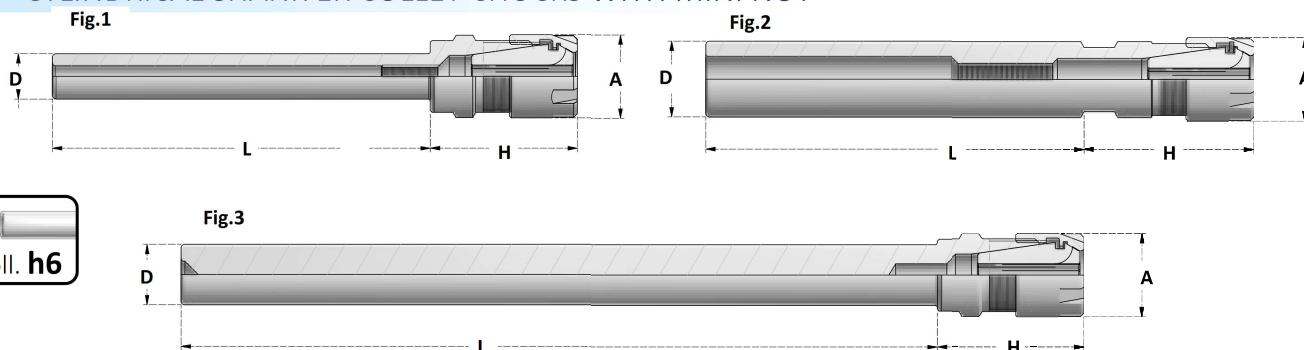

Articolo	D	A	L	H	Collets Range	Ghiera Nut	FIG	
D1/2-L2.36-ERC16M	12,7	22	59,9	38	1÷10	G16M	1	
D1/2-L3.93-ERC16M	*	12,7	22	99,8	38	1÷10	G16M	3
D1/2-L5.11-ERC16M	*	12,7	22	129,8	38	1÷10	G16M	3
D1/2-L6.29-ERC16M	*	12,7	22	159,8	38	1÷10	G16M	3
D5/8-L2.36-ERC16M	15,87	22	59,9	38	1÷10	G16M	1	
D5/8-L3.93-ERC16M	15,87	22	99,8	38	1÷10	G16M	1	
D5/8-L5.11-ERC16M	15,87	22	129,8	38	1÷10	G16M	1	
D5/8-L6.29-ERC16M	15,87	22	159,8	38	1÷10	G16M	1	
D3/4-L2.36-ERC16M	19,05	22	59,9	40	1÷10	G16M	2	
D3/4-L3.93-ERC16M	19,05	22	99,8	40	1÷10	G16M	2	
D3/4-L5.11-ERC16M	19,05	22	129,8	40	1÷10	G16M	2	
D3/4-L6.29-ERC16M	19,05	22	159,8	40	1÷10	G16M	2	
D1"-L2.36-ERC16M	25,4	22	59,9	40	1÷10	G16M	2	
D1"-L3.93-ERC16M	25,4	22	99,8	40	1÷10	G16M	2	
D1"-L5.11-ERC16M	25,4	22	129,8	40	1÷10	G16M	2	
D1"-L6.29-ERC16M	25,4	22	159,8	40	1÷10	G16M	2	

* = SENZA PASSAGGIO DEL REFRIGERANTE

* = WITHOUT COOLANT BORE



KIT - MANDRINO, CHIAVE E PINZE

KIT - TOOLHOLDER, WRENCH AND COLLETS

Articolo	Pinze Collets	Mandrino Chuck	Chiave Wrench
BX.D16.L100.16M	ERC16.D1÷10 x 1mm	D16.L100.ERC16M	CH16M
BX.D16.L130.16M	ERC16.D1÷10 x 1mm	D16.L130.ERC16M	CH16M
BX.D16.L160.16M	ERC16.D1÷10 x 1mm	D16.L160.ERC16M	CH16M
BX.D16.L200.16M	ERC16.D1÷10 x 1mm	D16.L200.ERC16M	CH16M
BX.D20.L100.16M	ERC16.D1÷10 x 1mm	D20.L100.ERC16M	CH16M
BX.D20.L130.16M	ERC16.D1÷10 x 1mm	D20.L130.ERC16M	CH16M
BX.D20.L160.16M	ERC16.D1÷10 x 1mm	D20.L160.ERC16M	CH16M
BX.D20.L200.16M	ERC16.D1÷10 x 1mm	D20.L200.ERC16M	CH16M

ALTRI A RICHIESTA
OTHERS ON REQUEST

ACCESSORI - ACCESSORIES



PROLUNGHE CILINDRICHE PORTAPINZA ER CON GHIERA ESAGONALE
CYLINDRICAL SHANK ER COLLET CHUCKS WITH HEXAGONAL NUT

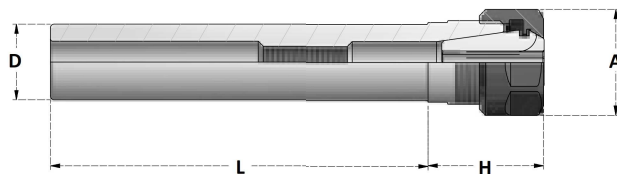
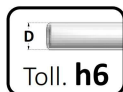

Articolo	D	A	L	H	Collets Range	Ghiera Nut
D16.L60.ERC16	16	28	60	31	1÷10	G16SE
D16.L80.ERC16	16	28	80	31	1÷10	G16SE
D16.L100.ERC16	16	28	100	31	1÷10	G16SE
D16.L130.ERC16	16	28	130	31	1÷10	G16SE
D16.L160.ERC16	16	28	160	31	1÷10	G16SE
D20.L60.ERC16	20	28	60	31	1÷10	G16SE
D20.L80.ERC16	20	28	80	31	1÷10	G16SE
D20.L100.ERC16	20	28	100	31	1÷10	G16SE
D20.L130.ERC16	20	28	130	31	1÷10	G16SE
D20.L160.ERC16	20	28	160	31	1÷10	G16SE

Articolo	D	A	L	H	Collets Range	Ghiera Nut
D1/2-L2.36-ERC16	12,7	28	59,9	31	1÷10	G16SE
D1/2-L3.93-ERC16	12,7	28	99,8	31	1÷10	G16SE
D1/2-L5.11-ERC16	12,7	28	129,8	31	1÷10	G16SE
D1/2-L6.29-ERC16	12,7	28	159,8	31	1÷10	G16SE
D5/8-L2.36-ERC16	15,87	28	59,9	31	1÷10	G16SE
D5/8-L3.93-ERC16	15,87	28	99,8	31	1÷10	G16SE
D5/8-L5.11-ERC16	15,87	28	129,8	31	1÷10	G16SE
D5/8-L6.29-ERC16	15,87	28	159,8	31	1÷10	G16SE
D3/4-L2.36-ERC16	19,05	28	59,9	31	1÷10	G16SE
D3/4-L3.93-ERC16	19,05	28	99,8	31	1÷10	G16SE
D3/4-L5.11-ERC16	19,05	28	129,8	31	1÷10	G16SE
D3/4-L6.29-ERC16	19,05	28	159,8	31	1÷10	G16SE

ACCESSORI - ACCESSORIES

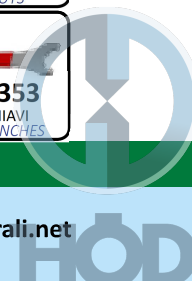
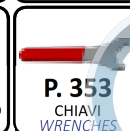

PROLUNGHE CILINDRICHE PORTAPINZA ER CON GHIERA MINI
CYLINDRICAL SHANK ER COLLET CHUCKS WITH MINI NUT

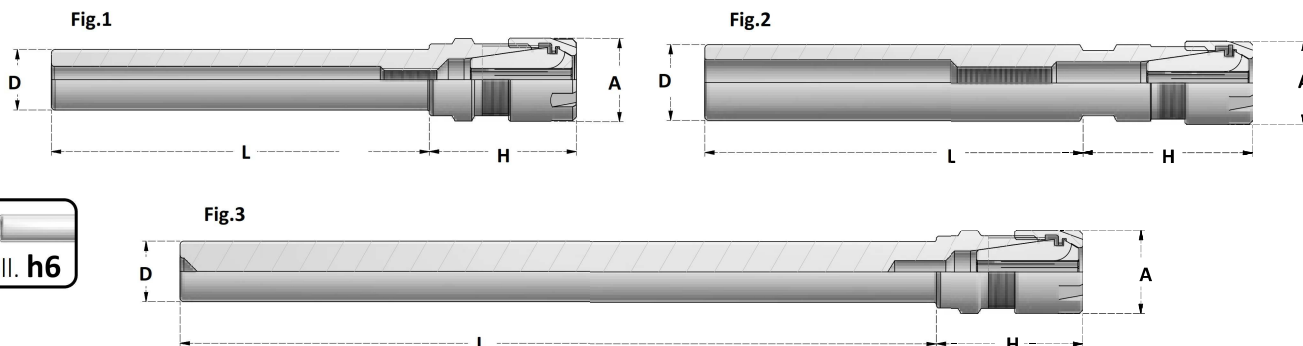

Articolo	D	A	L	H	Collets Range	Ghiera Nut	FIG	
D16.L60.ERC20M	16	28	60	41,5	1÷14	G20M	1	
D16.L80.ERC20M	16	28	80	41,5	1÷14	G20M	1	
D16.L100.ERC20M	16	28	100	41,5	1÷14	G20M	1	
D16.L130.ERC20M	16	28	130	41,5	1÷14	G20M	1	
D16.L160.ERC20M	16	28	160	41,5	1÷14	G20M	1	
D16.L200.ERC20M	*	16	28	200	41,5	1÷14	G20M	3
D16.L250.ERC20M	*	16	28	250	41,5	1÷14	G20M	3
D16.L300.ERC20M	*	16	28	300	41,5	1÷14	G20M	3
D20.L60.ERC20M		20	28	60	36,5	1÷14	G20M	1
D20.L80.ERC20M		20	28	80	36,5	1÷14	G20M	1
D20.L100.ERC20M		20	28	100	36,5	1÷14	G20M	1
D20.L130.ERC20M		20	28	130	36,5	1÷14	G20M	1
D20.L160.ERC20M		20	28	160	36,5	1÷14	G20M	1
D20.L200.ERC20M		20	28	200	36,5	1÷14	G20M	1
D20.L250.ERC20M		20	28	250	36,5	1÷14	G20M	1
D20.L300.ERC20M	*	20	28	300	36,5	1÷14	G20M	3
D25.L60.ERC20M		25	28	60	44,5	1÷14	G20M	2
D25.L80.ERC20M		25	28	80	44,5	1÷14	G20M	2
D25.L100.ERC20M		25	28	100	44,5	1÷14	G20M	2
D25.L130.ERC20M		25	28	130	44,5	1÷14	G20M	2
D25.L160.ERC20M		25	28	160	44,5	1÷14	G20M	2
D25.L200.ERC20M		25	28	200	44,5	1÷14	G20M	2
D25.L250.ERC20M		25	28	250	44,5	1÷14	G20M	2
D25.L300.ERC20M		25	28	300	44,5	1÷14	G20M	2

* = SENZA PASSAGGIO DEL REFRIGERANTE

* = WITHOUT COOLANT BORE

KIT - MANDRINO, CHIAVE E PINZE

KIT - TOOLHOLDER, WRENCH AND COLLETS

Articolo	Pinze Collets	Mandrino Chuck	Chiave Wrench
BX.D16.L100.20M	ERC20.D2÷13 x 1mm	D16.L100.ERC20M	CH20M
BX.D16.L130.20M	ERC20.D2÷13 x 1mm	D16.L130.ERC20M	CH20M
BX.D16.L160.20M	ERC20.D2÷13 x 1mm	D16.L160.ERC20M	CH20M
BX.D16.L200.20M	ERC20.D2÷13 x 1mm	D16.L200.ERC20M	CH20M
BX.D20.L100.20M	ERC20.D2÷13 x 1mm	D20.L100.ERC20M	CH20M
BX.D20.L130.20M	ERC20.D2÷13 x 1mm	D20.L130.ERC20M	CH20M
BX.D20.L160.20M	ERC20.D2÷13 x 1mm	D20.L160.ERC20M	CH20M
BX.D20.L200.20M	ERC20.D2÷13 x 1mm	D20.L200.ERC20M	CH20M

ALTRI A RICHIESTA
OTHERS ON REQUEST



ACCESSORI - ACCESSORIES

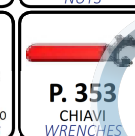
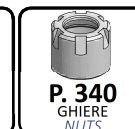

PROLUNGHE CILINDRICHE PORTAPINZA ER CON GHIERA MINI
CYLINDRICAL SHANK ER COLLET CHUCKS WITH MINI NUT

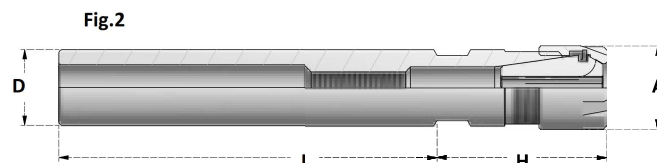
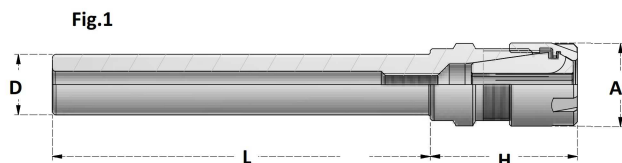
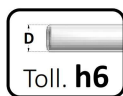

Articolo	D	A	L	H	Collets Range	Ghiera Nut	FIG
D1/2-L2.36-ERC20M	12,7	28	59,9	41,5	1÷14	G20M	1
D1/2-L3.93-ERC20M	12,7	28	99,8	41,5	1÷14	G20M	1
D1/2-L5.11-ERC20M	12,7	28	129,8	41,5	1÷14	G20M	1
D1/2-L6.29-ERC20M	12,7	28	159,8	41,5	1÷14	G20M	1
D5/8-L2.36-ERC20M	15,87	28	59,9	41,5	1÷14	G20M	1
D5/8-L3.93-ERC20M	15,87	28	99,8	41,5	1÷14	G20M	1
D5/8-L5.11-ERC20M	15,87	28	129,8	41,5	1÷14	G20M	1
D5/8-L6.29-ERC20M	15,87	28	159,8	41,5	1÷14	G20M	1
D3/4-L2.36-ERC20M	19,05	28	59,9	36,5	1÷14	G20M	1
D3/4-L3.93-ERC20M	19,05	28	99,8	36,5	1÷14	G20M	1
D3/4-L5.11-ERC20M	19,05	28	129,8	36,5	1÷14	G20M	1
D3/4-L6.29-ERC20M	19,05	28	159,8	36,5	1÷14	G20M	1
D1"-L2.36-ERC20M	25,4	28	59,9	44,5	1÷14	G20M	2
D1"-L3.93-ERC20M	25,4	28	99,8	44,5	1÷14	G20M	2
D1"-L5.11-ERC20M	25,4	28	129,8	44,5	1÷14	G20M	2
D1"-L6.29-ERC20M	25,4	28	159,8	44,5	1÷14	G20M	2

ACCESSORI - ACCESSORIES

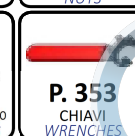
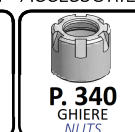
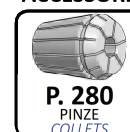

PROLUNGHE CILINDRICHE PORTAPINZA ER CON GHIERA STANDARD ESAGONALE
CYLINDRICAL SHANK ER COLLET CHUCKS WITH STANDARD HEXAGONAL NUT

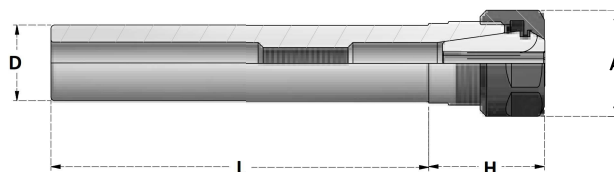

Articolo	D	A	L	H	Collets Range	Ghiera Nut
D20.L60.ERC20	20	34	60	36,5	1÷14	G20SE
D20.L80.ERC20	20	34	80	36,5	1÷14	G20SE
D20.L100.ERC20	20	34	100	36,5	1÷14	G20SE
D20.L130.ERC20	20	34	130	36,5	1÷14	G20SE
D20.L160.ERC20	20	34	160	36,5	1÷14	G20SE
D25.L60.ERC20	25	34	60	44,5	1÷14	G20SE
D25.L80.ERC20	25	34	80	44,5	1÷14	G20SE
D25.L100.ERC20	25	34	100	44,5	1÷14	G20SE
D25.L130.ERC20	25	34	130	44,5	1÷14	G20SE
D25.L160.ERC20	25	34	160	44,5	1÷14	G20SE

Articolo	D	A	L	H	Collets Range	Ghiera Nut
D3/4-L2.36-ERC20	19,05	34	59,9	36,5	1÷14	G20SE
D3/4-L3.93-ERC20	19,05	34	99,8	36,5	1÷14	G20SE
D3/4-L5.11-ERC20	19,05	34	129,8	36,5	1÷14	G20SE
D3/4-L6.29-ERC20	19,05	34	159,8	36,5	1÷14	G20SE
D1"-L2.36-ERC20	25,4	34	59,9	44,5	1÷14	G20SE
D1"-L3.93-ERC20	25,4	34	99,8	44,5	1÷14	G20SE
D1"-L5.11-ERC20	25,4	34	129,8	44,5	1÷14	G20SE
D1"-L6.83-ERC20	25,4	34	159,8	44,5	1÷14	G20SE

ACCESSORI - ACCESSORIES

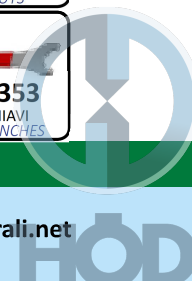
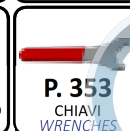

PROLUNGHE CILINDRICHE PORTAPINZA ER CON GHIERA MINI
CYLINDRICAL SHANK ER COLLET CHUCKS WITH MINI NUT

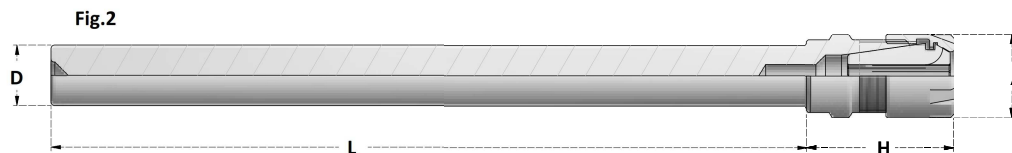
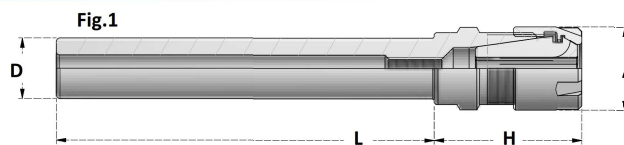

Articolo	D	A	L	H	Collets Range	Ghiera Nut	FIG
D20.L60.ERC25M	20	35	60	46	1÷20	G25M	1
D20.L80.ERC25M	20	35	80	46	1÷20	G25M	1
D20.L100.ERC25M	20	35	100	46	1÷20	G25M	1
D20.L130.ERC25M	20	35	130	46	1÷20	G25M	1
D20.L160.ERC25M	20	35	160	46	1÷20	G25M	1
D20.L200.ERC25M	20	35	200	46	1÷20	G25M	1
D20.L250.ERC25M	20	35	250	46	1÷20	G25M	2
D20.L300.ERC25M	*	20	35	300	1÷20	G25M	2
D25.L60.ERC25M	25	35	60	40	1÷20	G25M	1
D25.L80.ERC25M	25	35	80	40	1÷20	G25M	1
D25.L100.ERC25M	25	35	100	40	1÷20	G25M	1
D25.L130.ERC25M	25	35	130	40	1÷20	G25M	1
D25.L160.ERC25M	25	35	160	40	1÷20	G25M	1
D25.L200.ERC25M	25	35	200	40	1÷20	G25M	1
D25.L250.ERC25M	25	35	250	40	1÷20	G25M	1
D25.L300.ERC25M	25	35	300	40	1÷20	G25M	1

* = SENZA PASSAGGIO DEL REFRIGERANTE

* = WITHOUT COOLANT BORE

Articolo	D	A	L	H	Collets Range	Ghiera Nut
D3/4-L2.36-ERC25M	19,05	35	59,9	46	1÷20	G25M
D3/4-L3.93-ERC25M	19,05	35	99,8	46	1÷20	G25M
D3/4-L5.11-ERC25M	19,05	35	129,8	46	1÷20	G25M
D3/4-L6.29-ERC25M	19,05	35	159,8	46	1÷20	G25M
D1"-L2.36-ERC25M	25,4	35	59,9	40	1÷20	G25M
D1"-L3.93-ERC25M	25,4	35	99,8	40	1÷20	G25M
D1"-L5.11-ERC25M	25,4	35	129,8	40	1÷20	G25M
D1"-L6.29-ERC25M	25,4	35	159,8	40	1÷20	G25M

KIT - MANDRINO, CHIAVE E PINZE

KIT - TOOLHOLDER, WRENCH AND COLLETS

Articolo	Pinze Collets	Mandrino Chuck	Chiave Wrench
BX.D20.L100.25M	ERC25.D2÷16 x 1mm	D20.L100.ERC25M	CH25M
BX.D20.L130.25M	ERC25.D2÷16 x 1mm	D20.L130.ERC25M	CH25M
BX.D20.L160.25M	ERC25.D2÷16 x 1mm	D20.L160.ERC25M	CH25M
BX.D20.L200.25M	ERC25.D2÷16 x 1mm	D20.L200.ERC25M	CH25M
BX.D25.L100.25M	ERC25.D2÷16 x 1mm	D25.L100.ERC25M	CH25M
BX.D25.L130.25M	ERC25.D2÷16 x 1mm	D25.L130.ERC25M	CH25M
BX.D25.L160.25M	ERC25.D2÷16 x 1mm	D25.L160.ERC25M	CH25M
BX.D25.L200.25M	ERC25.D2÷16 x 1mm	D25.L200.ERC25M	CH25M

ALTRI A RICHIESTA
OTHERS ON REQUEST



ACCESSORI - ACCESSORIES

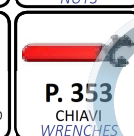
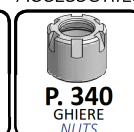

PROLUNGHE CILINDRICHE PORTAPINZA ER CON GHIERA STANDARD
CYLINDRICAL SHANK ER COLLET CHUCKS WITH STANDARD NUT

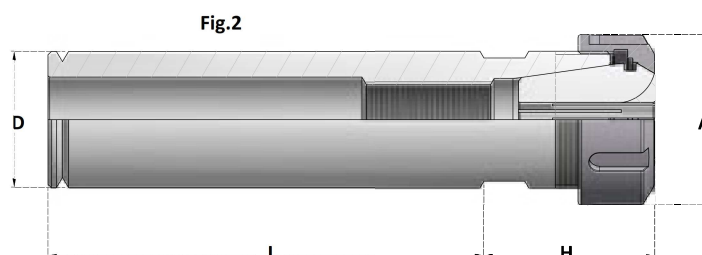
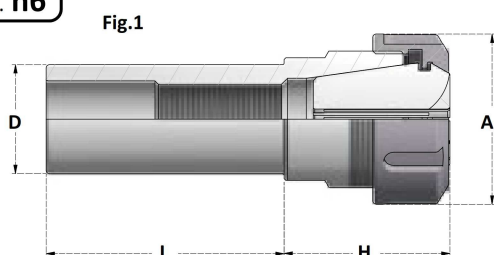

Articolo	D	A	L	H	Collets Range	Ghiera Nut	FIG
D20.L60.ERC25	20	42	60	46	1÷20	G25S	1
D20.L80.ERC25	20	42	80	46	1÷20	G25S	1
D20.L100.ERC25	20	42	100	46	1÷20	G25S	1
D20.L130.ERC25	20	42	130	46	1÷20	G25S	1
D20.L160.ERC25	20	42	160	46	1÷20	G25S	1
D25.L60.ERC25	25	42	60	40	1÷20	G25S	1
D25.L80.ERC25	25	42	80	40	1÷20	G25S	1
D25.L100.ERC25	25	42	100	40	1÷20	G25S	1
D25.L130.ERC25	25	42	130	40	1÷20	G25S	1
D25.L160.ERC25	25	42	160	40	1÷20	G25S	1
D32.L60.ERC25	32	42	60	44	1÷20	G25S	2
D32.L80.ERC25	32	42	80	44	1÷20	G25S	2
D32.L100.ERC25	32	42	100	44	1÷20	G25S	2
D32.L130.ERC25	32	42	130	44	1÷20	G25S	2
D32.L160.ERC25	32	42	160	44	1÷20	G25S	2
D40.L60.ERC25	40	42	60	49	1÷20	G25S	2
D40.L80.ERC25	40	42	80	49	1÷20	G25S	2
D40.L100.ERC25	40	42	100	49	1÷20	G25S	2
D40.L130.ERC25	40	42	130	49	1÷20	G25S	2
D40.L160.ERC25	40	42	160	49	1÷20	G25S	2

KIT - MANDRINO, CHIAVE E PINZE

KIT - TOOLHOLDER, WRENCH AND COLLETS

Articolo	Pinze Collets	Mandrino Chuck	Chiave Wrench
BX.D20.L80.25	ERC25.D2÷16 x 1mm	D20.L80.ERC25	CH25S
BX.D20.L100.25	ERC25.D2÷16 x 1mm	D20.L100.ERC25	CH25S
BX.D25.L80.25	ERC25.D2÷16 x 1mm	D25.L80.ERC25	CH25S
BX.D25.L100.25	ERC25.D2÷16 x 1mm	D25.L100.ERC25	CH25S
BX.D32.L80.25	ERC25.D2÷16 x 1mm	D32.L80.ERC25	CH25S
BX.D32.L100.25	ERC25.D2÷16 x 1mm	D32.L100.ERC25	CH25S
BX.D40.L80.25	ERC25.D2÷16 x 1mm	D40.L80.ERC25	CH25S
BX.D40.L100.25	ERC25.D2÷16 x 1mm	D40.L100.ERC25	CH25S

ALTRI A RICHIESTA
OTHERS ON REQUEST

ACCESSORI - ACCESSORIES

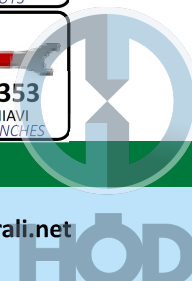
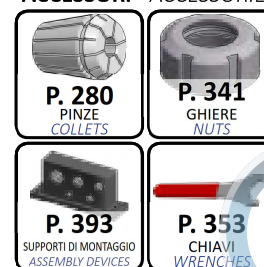

PROLUNGHE CILINDRICHE PORTAPINZA ER CON GHIERA STANDARD
CYLINDRICAL SHANK ER COLLET CHUCKS WITH STANDARD NUT

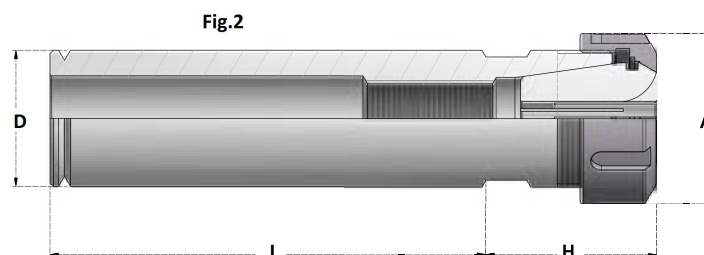
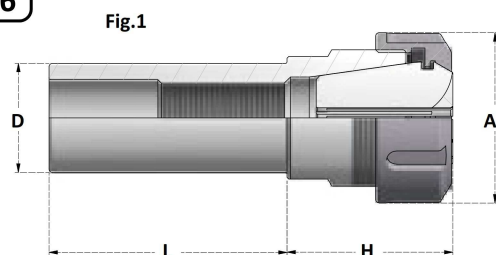

Articolo	D	A	L	H	Collets Range	Ghiera Nut	FIG
D3/4-L2.36-ERC25	19,05	42	59,9	46	1÷20	G25S	1
D3/4-L3.93-ERC25	19,05	42	99,8	46	1÷20	G25S	1
D3/4-L5.11-ERC25	19,05	42	129,8	46	1÷20	G25S	1
D1"-L2.36-ERC25	25,4	42	59,9	40	1÷20	G25S	1
D1"-L3.93-ERC25	25,4	42	99,8	40	1÷20	G25S	1
D1"-L5.11-ERC25	25,4	42	129,8	40	1÷20	G25S	1
D1-1/4-L2.36-ERC25	31,75	42	59,9	44	1÷20	G25S	2
D1-1/4-L3.93-ERC25	31,75	42	99,8	44	1÷20	G25S	2
D1-1/4-L5.11-ERC25	31,75	42	129,8	44	1÷20	G25S	2
D1-1/2-L2.36-ERC25	38,1	42	59,9	49	1÷20	G25S	2
D1-1/2-L3.93-ERC25	38,1	42	99,8	49	1÷20	G25S	2
D1-1/2-L5.11-ERC25	38,1	42	129,8	49	1÷20	G25S	2
D1-3/4-L2.36-ERC25	44,45	42	59,9	49	1÷20	G25S	2
D1-3/4-L3.93-ERC25	44,45	42	99,8	49	1÷20	G25S	2
D1-3/4-L5.11-ERC25	44,45	42	129,8	49	1÷20	G25S	2

ACCESSORI - ACCESSORIES

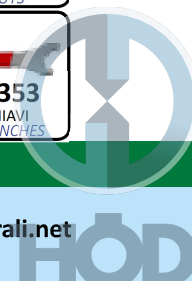
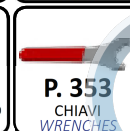
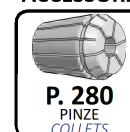

PROLUNGHE CILINDRICHE PORTAPINZA ER CON GHIERA STANDARD
CYLINDRICAL SHANK ER COLLET CHUCKS WITH STANDARD NUT

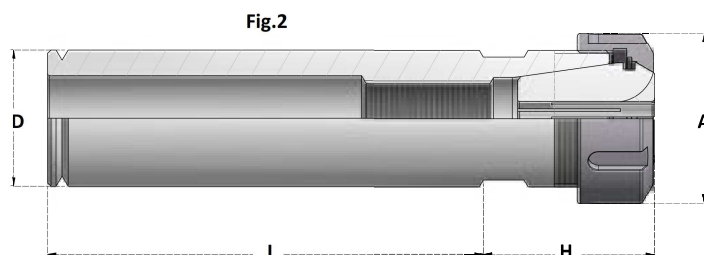
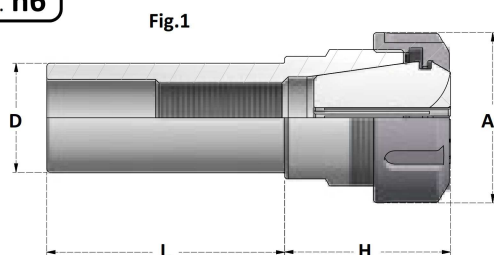

Articolo	D	A	L	H	Collets Range	Ghiera Nut	FIG
D20.L60.ERC32	20	50	60	53	2÷22	G32S	1
D20.L80.ERC32	20	50	80	53	2÷22	G32S	1
D20.L100.ERC32	20	50	100	53	2÷22	G32S	1
D20.L130.ERC32	20	50	130	53	2÷22	G32S	1
D20.L160.ERC32	20	50	160	53	2÷22	G32S	1
D25.L60.ERC32	25	50	60	53	2÷22	G32S	1
D25.L80.ERC32	25	50	80	53	2÷22	G32S	1
D25.L100.ERC32	25	50	100	53	2÷22	G32S	1
D25.L130.ERC32	25	50	130	53	2÷22	G32S	1
D25.L160.ERC32	25	50	160	53	2÷22	G32S	1
D32.L60.ERC32	32	50	60	48	2÷22	G32S	1
D32.L80.ERC32	32	50	80	48	2÷22	G32S	1
D32.L100.ERC32	32	50	100	48	2÷22	G32S	1
D32.L130.ERC32	32	50	130	48	2÷22	G32S	1
D32.L160.ERC32	32	50	160	48	2÷22	G32S	1
D40.L60.ERC32	40	50	60	50	2÷22	G32S	2
D40.L80.ERC32	40	50	80	50	2÷22	G32S	2
D40.L100.ERC32	40	50	100	50	2÷22	G32S	2
D40.L130.ERC32	40	50	130	50	2÷22	G32S	2
D40.L160.ERC32	40	50	160	50	2÷22	G32S	2
D50.L130.ERC32	50	50	130	47	2÷22	G32S	2
D50.L160.ERC32	50	50	160	47	2÷22	G32S	2

KIT - MANDRINO, CHIAVE E PINZE

KIT - TOOLHOLDER, WRENCH AND COLLETS

Articolo	Pinze Collets	Mandrino Chuck	Chiave Wrench
BX.D20.L80.32	ERC32.D3 ÷ D20 x 1mm	D20.L80.ERC32	G32S
BX.D20.L100.32	ERC32.D3 ÷ D20 x 1mm	D20.L100.ERC32	G32S
BX.D25.L80.32	ERC32.D3 ÷ D20 x 1mm	D25.L80.ERC32	G32S
BX.D25.L100.32	ERC32.D3 ÷ D20 x 1mm	D25.L100.ERC32	G32S
BX.D32.L80.32	ERC32.D3 ÷ D20 x 1mm	D32.L80.ERC32	G32S
BX.D32.L100.32	ERC32.D3 ÷ D20 x 1mm	D32.L100.ERC32	G32S
BX.D40.L80.32	ERC32.D3 ÷ D20 x 1mm	D40.L80.ERC32	G32S
BX.D40.L100.32	ERC32.D3 ÷ D20 x 1mm	D40.L100.ERC32	G32S

ALTRI A RICHIESTA
OTHERS ON REQUEST

ACCESSORI - ACCESSORIES

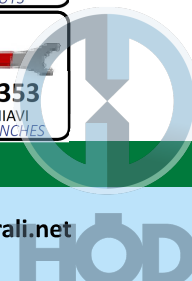
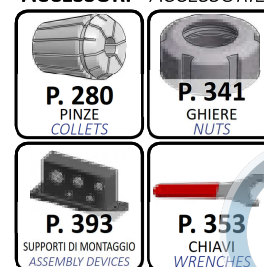

PROLUNGHE CILINDRICHE PORTAPINZA ER CON GHIERA STANDARD
CYLINDRICAL SHANK ER COLLET CHUCKS WITH STANDARD NUT

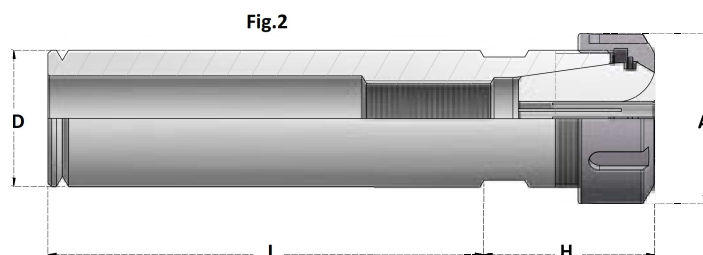
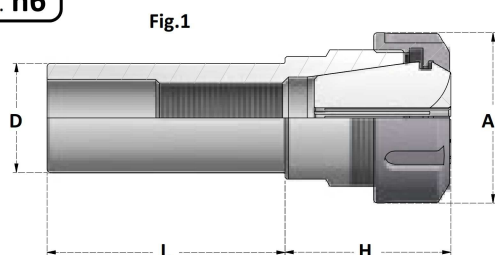
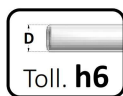

Articolo	D	A	L	H	Collets Range	Ghiera Nut	FIG
D3/4-L2.36-ERC32	19,05	50	59,9	53	2÷22	G32S	1
D3/4-L3.93-ERC32	19,05	50	99,8	53	2÷22	G32S	1
D3/4-L5.11-ERC32	19,05	50	129,8	53	2÷22	G32S	1
D1"-L2.36-ERC32	25,4	50	59,9	53	2÷22	G32S	1
D1"-L3.93-ERC32	25,4	50	99,8	53	2÷22	G32S	1
D1"-L5.11-ERC32	25,4	50	129,8	53	2÷22	G32S	1
D1-1/4-L2.36-ERC32	31,75	50	59,9	48	2÷22	G32S	1
D1-1/4-L3.93-ERC32	31,75	50	99,8	48	2÷22	G32S	1
D1-1/4-L5.11-ERC32	31,75	50	129,8	48	2÷22	G32S	1
D1-1/2-L2.36-ERC32	38,1	50	59,9	50	2÷22	G32S	1
D1-1/2-L3.93-ERC32	38,1	50	99,8	50	2÷22	G32S	1
D1-1/2-L5.11-ERC32	38,1	50	129,8	50	2÷22	G32S	1
D1-3/4-L2.36-ERC32	44,45	50	59,9	50	2÷22	G32S	2
D1-3/4-L3.93-ERC32	44,45	50	99,8	50	2÷22	G32S	2
D1-3/4-L5.11-ERC32	44,45	50	129,8	50	2÷22	G32S	2

ACCESSORI - ACCESSORIES



PROLUNGHE CILINDRICHE PORTAPINZA ER CON GHIERA STANDARD
CYLINDRICAL SHANK ER COLLET CHUCKS WITH STANDARD NUT

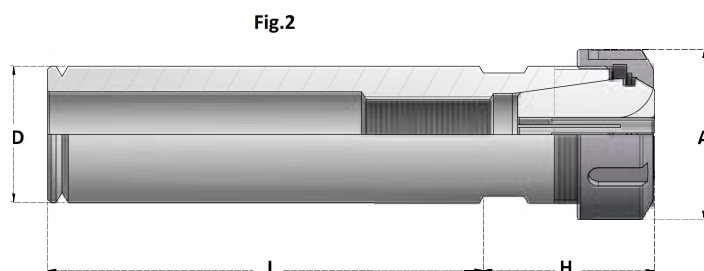
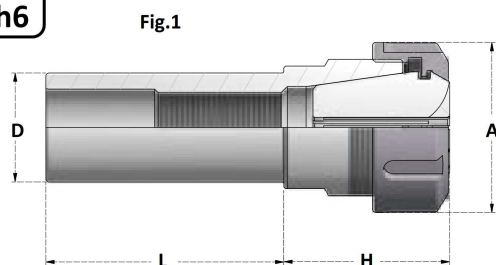

Articolo	D	A	L	H	Collets Range	Ghiera Nut	FIG
D25.L60.ERC40	25	63	60	61	3÷30	G40S	1
D25.L80.ERC40	25	63	80	61	3÷30	G40S	1
D25.L100.ERC40	25	63	100	61	3÷30	G40S	1
D25.L130.ERC40	25	63	130	61	3÷30	G40S	1
D25.L160.ERC40	25	63	160	61	3÷30	G40S	1
D32.L60.ERC40	32	63	60	61	3÷30	G40S	1
D32.L80.ERC40	32	63	80	61	3÷30	G40S	1
D32.L100.ERC40	32	63	100	61	3÷30	G40S	1
D32.L130.ERC40	32	63	130	61	3÷30	G40S	1
D32.L160.ERC40	32	63	160	61	3÷30	G40S	1
D40.L80.ERC40	40	63	80	65	3÷30	G40S	1
D40.L100.ERC40	40	63	100	65	3÷30	G40S	1
D40.L130.ERC40	40	63	130	65	3÷30	G40S	1
D40.L160.ERC40	40	63	160	65	3÷30	G40S	1
D50.L120.ERC40	50	63	120	59	3÷30	G40S	2
D50.L160.ERC40	50	63	160	59	3÷30	G40S	2
D60.L160.ERC40	60	63	160	59	3÷30	G40S	2

KIT - MANDRINO, CHIAVE E PINZE

KIT - TOOLHOLDER, WRENCH AND COLLETS

Articolo	Pinze Collets	Mandrino Chuck	Chiave Wrench
BX.D25.L80.40	ERC40.D4 ÷ D26 x 1mm	D25.L80.ERC40	CH40S
BX.D25.L100.40	ERC40.D4 ÷ D26 x 1mm	D25.L100.ERC40	CH40S
BX.D32.L80.40	ERC40.D4 ÷ D26 x 1mm	D32.L80.ERC40	CH40S
BX.D32.L100.40	ERC40.D4 ÷ D26 x 1mm	D32.L100.ERC40	CH40S
BX.D40.L80.40	ERC40.D4 ÷ D26 x 1mm	D40.L80.ERC40	CH40S
BX.D40.L100.40	ERC40.D4 ÷ D26 x 1mm	D40.L100.ERC40	CH40S

ALTRI A RICHIESTA
OTHERS ON REQUEST

ACCESSORI - ACCESSORIES

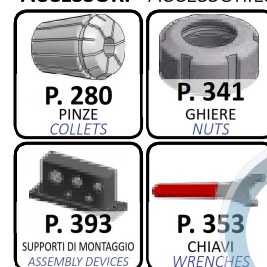

PROLUNGHE CILINDRICHE PORTAPINZA ER CON GHIERA STANDARD
CYLINDRICAL SHANK ER COLLET CHUCKS WITH STANDARD NUT

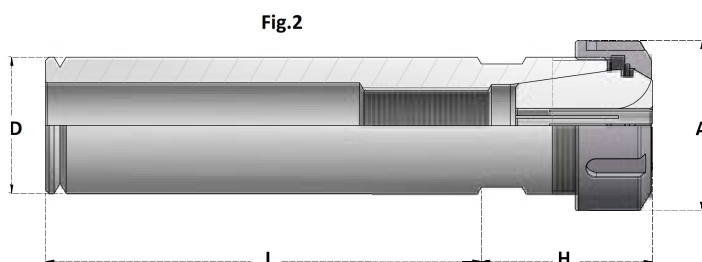
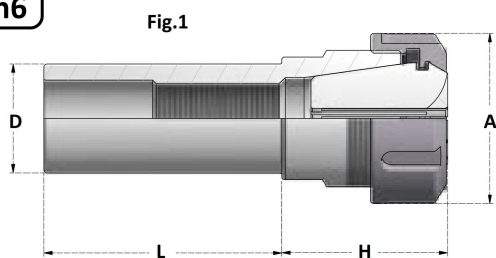
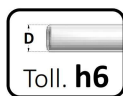

Articolo	D	A	L	H	Collets Range	Ghiera Nut	FIG
D1"-L2.36-ERC40	25,4	63	59,9	61	3÷30	G40S	1
D1"-L3.93-ERC40	25,4	63	99,8	61	3÷30	G40S	1
D1"-L5.11-ERC40	25,4	63	129,8	61	3÷30	G40S	1
D1-1/4-L2.36-ERC40	31,75	63	59,9	61	3÷30	G40S	1
D1-1/4-L3.93-ERC40	31,75	63	99,8	61	3÷30	G40S	1
D1-1/4-L5.11-ERC40	31,75	63	129,8	61	3÷30	G40S	1
D1-1/2-L2.36-ERC40	38,1	63	59,9	65	3÷30	G40S	1
D1-1/2-L3.93-ERC40	38,1	63	99,8	65	3÷30	G40S	1
D1-1/2-L5.11-ERC40	38,1	63	129,8	65	3÷30	G40S	1
D1-3/4-L3.93-ERC40	44,45	63	99,8	65	3÷30	G40S	2
D1-3/4-L5.11-ERC40	44,45	63	129,8	65	3÷30	G40S	2
D2"-L6.29-ERC40	50,8	63	159,8	65	3÷30	G40S	2

PROLUNGHE CILINDRICHE PORTAPINZA ER CON GHIERA STANDARD
CYLINDRICAL SHANK ER COLLET CHUCKS WITH STANDARD NUT

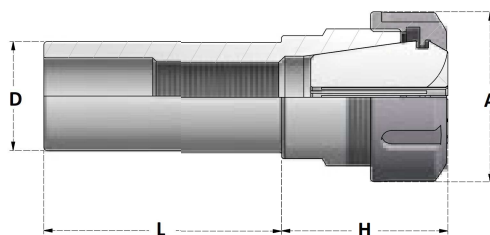
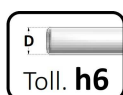

Articolo	D	A	L	H	Collets Range	Ghiera Nut
D40.L160.ERC50	40	78	160	65	6÷40	G50S
D50.L170.ERC50	50	78	170	65	6÷40	G50S
D60.L170.ERC50	60	78	170	65	6÷40	G50S

ACCESSORI - ACCESSORIES

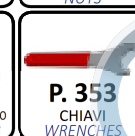

PROLUNGHE CILINDRICHE PORTAPINZA ER CON PIANO
CYLINDRICAL SHANK ER COLLET CHUCKS WITH FLAT

D
Toll. **h6**

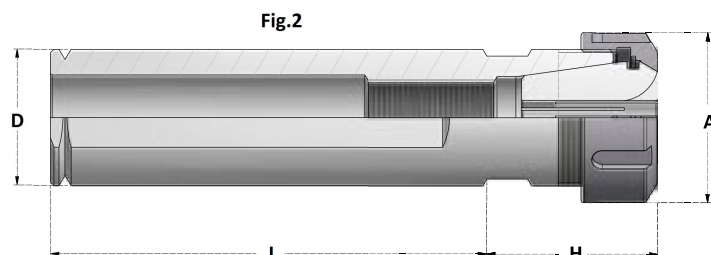
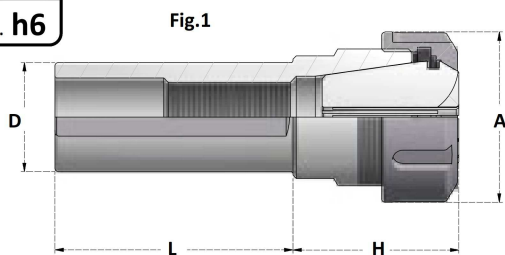

Articolo	D	A	L	H	Collets Range	Ghiera Nut	FIG
D20P.L80.ERC25	20	42	80	46	1÷20	G25S	1
D25P.L80.ERC25	25	42	80	40	1÷20	G25S	1
D32P.L80.ERC25	32	42	80	44	1÷20	G25S	2
D40P.L80.ERC25	40	42	80	49	1÷20	G25S	2
D20P.L80.ERC32	20	50	80	53	2÷22	G32S	1
D25P.L80.ERC32	25	50	80	53	2÷22	G32S	1
D32P.L80.ERC32	32	50	80	48	2÷22	G32S	1
D40P.L80.ERC32	40	50	80	50	2÷22	G32S	2
D25P.L80.ERC40	25	63	80	61	3÷30	G40S	1
D32P.L80.ERC40	32	63	80	61	3÷30	G40S	1
D40P.L80.ERC40	40	63	80	61	3÷30	G40S	1

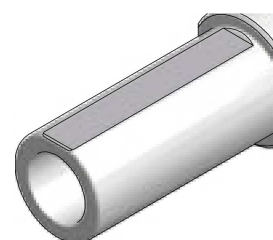

DIN 1835-1 Form B

DIN ISO 15488 (DIN6499)

PROLUNGHE CILINDRICHE PORTAPINZA CON PIANI WELDON
CYLINDRICAL SHANK ER COLLET CHUCKS WITH DIN1835 FLATS

GAMBO IN TOLLERANZA
SHANK TOLERANCE **h6**

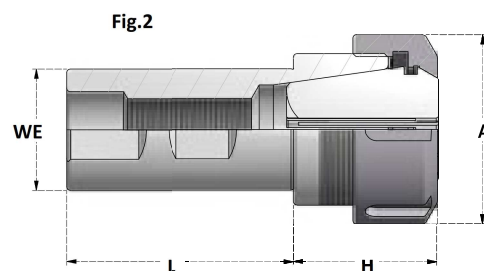
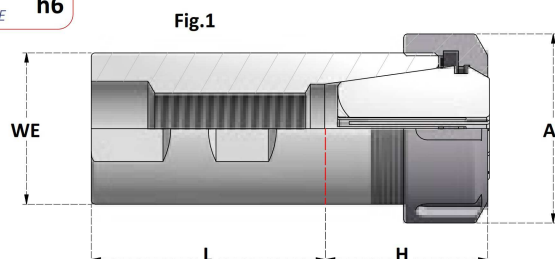

Articolo	WE	A	L	H	Collets Range	Ghiera Nut	FIG
WE20.L50.ERC16	20	28	50	31	1÷10	G16SE	2
WE20.L50.ERC25	20	42	50	46	1÷20	G25S	2
WE25.L56.ERC25	25	42	56	40	1÷20	G25S	2
WE25.L56.ERC32	25	50	56	53	2÷22	G32S	2
WE32.L60.ERC25	32	42	60	44	1÷20	G25S	1
WE32.L60.ERC32	32	50	60	38	2÷22	G32S	2
WE32.L60.ERC40	32	63	60	61	3÷30	G40S	2
WE40.L74.ERC32	40	50	74	31	2÷22	G32S	1
WE40.L74.ERC40	40	63	74	65	3÷30	G40S	2
WE50.L80.ERC40	50	63	80	37	3÷30	G40S	1

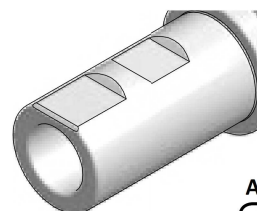

ACCESSORI - ACCESSORIES

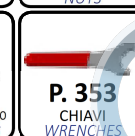

MANDRINI PORTAPINZA ER A CENTRATURA REGOLABILE
RUNOUT ADJUSTABLE ER COLLET CHUCKS

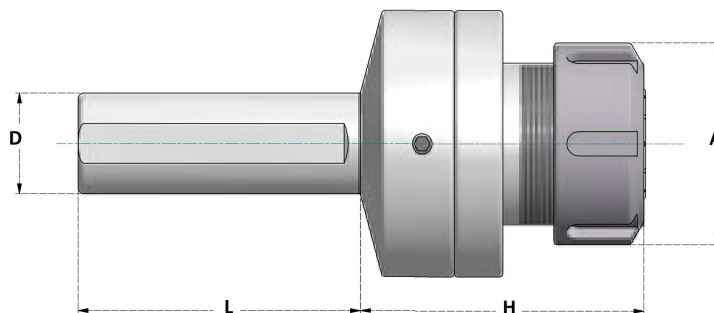

±0,1mm

Articolo	D	A	L	H	Collets Range	Ghiera Nut
D25P.L70.ERC16RG	25	28	70	66	1÷10	G16SE
D25P.L70.ERC20RG	25	34	70	68	1÷14	G20SE
D25P.L70.ERC25RG	25	42	70	69	1÷20	G25S
D25P.L70.ERC32RG	25	50	70	70	2÷22	G32S
D25P.L70.ERC40RG	25	63	70	104	3÷30	G40S
D32P.L70.ERC16RG	32	28	70	66	1÷10	G16SE
D32P.L70.ERC20RG	32	34	70	68	1÷14	G20SE
D32P.L70.ERC25RG	32	42	70	69	1÷20	G25S
D32P.L70.ERC32RG	32	50	70	70	2÷22	G32S
D32P.L70.ERC40RG	32	63	70	104	3÷30	G40S
D40P.L70.ERC16RG	40	28	70	64	1÷10	G16SE
D40P.L70.ERC20RG	40	34	70	66	1÷14	G20SE
D40P.L70.ERC25RG	40	42	70	67	1÷20	G25S
D40P.L70.ERC32RG	40	50	70	68	2÷22	G32S
D40P.L70.ERC40RG	40	63	70	102	3÷30	G40S

Centratura regolabile 0,1mm
Adjustable runout 0,1mm

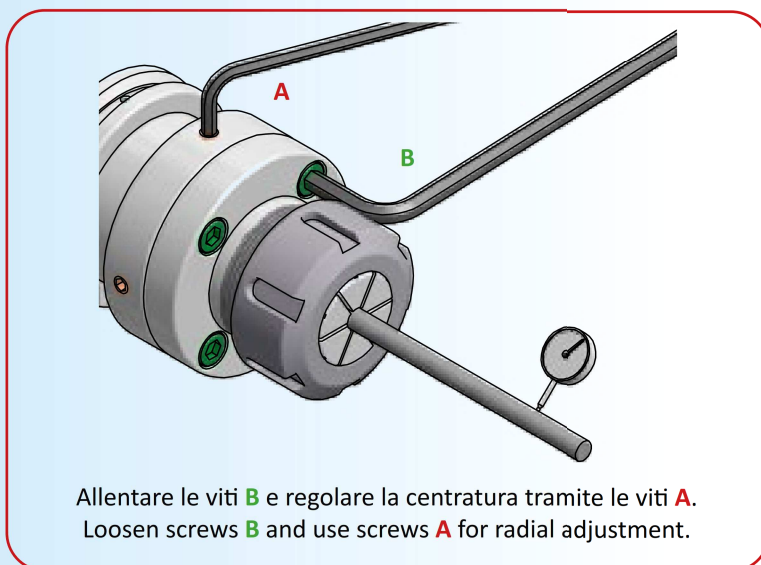
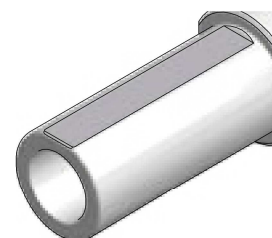

ACCESSORI - ACCESSORIES

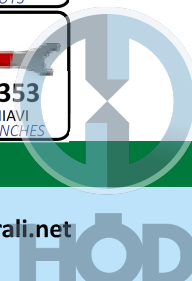
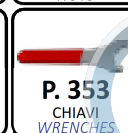

MANDRINI PORTAPINZA ER CON GHIERA MINI DOPPI
DOUBLE ER COLLET CHUCKS WITH MINI NUT

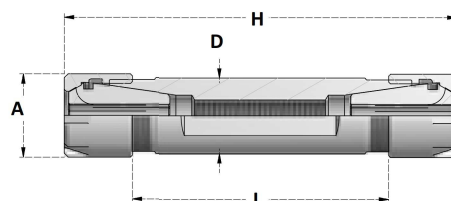
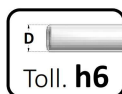

Articolo	D	A	L	H	Collets Range	Ghiera Nut
D16P.L40.ERC11M-11M	16	16	40	71	1÷7	G11M
D20P.L42.ERC11M-11M	20	16	42	70	1÷7	G11M
D20P.L52.ERC11M-11M	20	16	52	80	1÷7	G11M
D20P.L62.ERC11M-11M	20	16	62	90	1÷7	G11M
D20P.L37.ERC16M-16M	20	22	37	80	1÷10	G16M
D20P.L57.ERC16M-16M	20	22	57	100	1÷10	G16M
D20P.L67.ERC16M-16M	20	22	67	110	1÷10	G16M
D20P.L122.ERC16M-16M	20	22	122	165	1÷10	G16M
D22P.L27.ERC16M-16M	22	22	27	70	1÷10	G16M
D22P.L47.ERC16M-16M	22	22	47	90	1÷10	G16M
D22P.L67.ERC16M-16M	22	22	67	110	1÷10	G16M
D22P.L102.ERC16M-16M	22	22	102	145	1÷10	G16M
D22P.L122.ERC16M-16M	22	22	122	165	1÷10	G16M
D25P.L27.ERC16M-16M	25	22	27	70	1÷10	G16M
D25P.L47.ERC16M-16M	25	22	47	90	1÷10	G16M
D25P.L67.ERC16M-16M	25	22	67	110	1÷10	G16M
D25P.L82.ERC20M-20M	25	28	82	130	1÷14	G20M
D32P.L57.ERC20M-20M	32	28	57	105	1÷14	G20M
D32P.L82.ERC20M-20M	32	28	82	130	1÷14	G20M

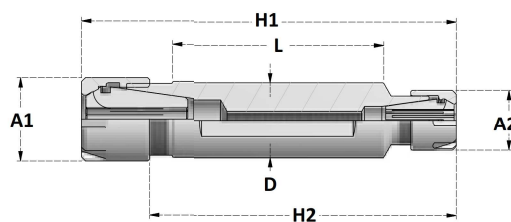
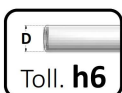

Articolo	D	A1	A2	L	H1	H2	Collets Range	Ghiera Nut	Collets Range	Ghiera Nut
D20P.L50.ERC16M-11M	20	22	16	50	85	68	1÷10	G16M	1÷7	G11M
D20P.L50.ERC20M-11M	20	28	16	50	91	72	1÷14	G20M	1÷7	G11M
D22P.L45.ERC20M-16M	22	28	22	45	90	71	1÷14	G20M	1÷10	G16M
D22P.L60.ERC20M-16M	22	28	22	60	105	86	1÷14	G20M	1÷10	G16M
D25P.L45.ERC20M-16M	25	28	22	45	90	71	1÷14	G20M	1÷10	G16M
D25P.L60.ERC20M-16M	25	28	22	60	105	86	1÷14	G20M	1÷10	G16M
D25P.L45.ERC25M-16M	25	35	22	45	91	71	1÷20	G25M	1÷10	G16M
D25P.L50.ERC25M-16M	25	35	22	50	106	86	1÷20	G25M	1÷10	G16M
D32P.L60.ERC25M-20M	32	35	28	60	108	88	1÷20	G25M	1÷14	G20M

ACCESSORI - ACCESSORIES

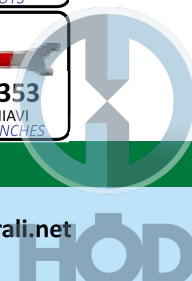
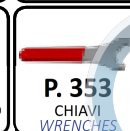
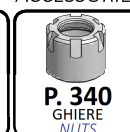

CYLINDRICAL COLLET CHUCKS WITH MINI NUT

SPANNFUTTER MIT ZYLINDERSCHAFT MIT MINI SPANNMUTTER

PORTAPINZAS CILINDRICO CON TUERCA MINI

ЦАНГОВЫЕ ПАТРОНЫ С ЦИЛИНДРИЧЕСКИМ

ХВОСТОВИКОМ С МИНИ-ГАЙКОЙ

PORTAPINZA GAMBO CILINDRICO CON GHIERA MINI

PORTE PINCES QUEUE CYLINDRIQUE AVEC ECROU MINI

带微型螺母的圆柱式弹簧夹头

DIN6499/ISO15488

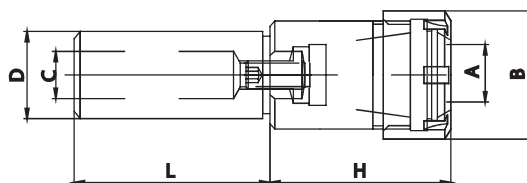

CODE N.	DESCRIPTION	Dh6	L	H	B	C	CLAMPLING CAPACITY	NUT	DESCRIPTION
214-35101	D6L45ER8M	6	45	24	12	-	1÷5	812-203011	ER8M
214-35139	D6L45ER11M	6	45	25	16	-	1÷7	812-203012	ER11M
214-35102	D8L55ER8M	8	55	24	12	-	1÷5	812-203011	ER8M
214-35108	D8L80ER8M	8	80	24	12	-	1÷5	812-203011	ER8M
214-35714	D8L100ER8M	8	100	24	12	-	1÷5	812-203011	ER8M
214-35715	D8L130ER8M	8	130	24	12	-	1÷5	812-203011	ER8M
214-35109	D8L55ER11M	8	55	25	16	-	1÷7	812-203012	ER11M
264-35116	D8L100ER11M	8	100	25	16	-	1÷7	812-203012	ER11M
214-35716	D8L55ER16M	8	55	37	22	-	1÷10	812-203013	ER16M
264-35117	D10L55ER8M	10	55	24	12	5	1÷5	812-203011	ER8M
214-35718	D10L80ER8M	10	80	24	12	5	1÷5	812-203011	ER8M
264-35118	D10L100ER8M	10	100	18	12	5	1÷5	812-203011	ER8M
214-35719	D10L130ER8M	10	130	24	12	5	1÷5	812-203011	ER8M
214-35110	D10L55ER11M	10	55	25	16	5	1÷7	812-203012	ER11M
214-35720	D10L80ER11M	10	80	25	16	5	1÷7	812-203012	ER11M
264-35119	D10L100ER11M	10	100	27	16	5	1÷7	812-203012	ER11M
214-35721	D10L130ER11M	10	130	25	16	5	1÷7	812-203012	ER11M
214-35113	D10L60ER16M	10	60	39	22	5	1÷10	812-203013	ER16M
264-35120	D10L100ER16M	10	100	37	22	5	1÷10	812-203013	ER16M
214-35723	D12L55ER8M	12	55	15	12	5	1÷5	812-203011	ER8M
214-35724	D12L70ER8M	12	70	15	12	5	1÷5	812-203011	ER8M
214-35140	D12L100ER8M	12	100	18	12	5	1÷5	812-203011	ER8M
264-35121	D12L140ER8M	12	140	18	12	5	1÷5	812-203011	ER8M
264-35122	D12L55ER11M	12	55	25	16	7	1÷7	812-203012	ER11M
214-35141	D12L70ER11M	12	70	27	16	7	1÷7	812-203012	ER11M
214-35142	D12L100ER11M	12	100	27	16	7	1÷7	812-203012	ER11M
214-35143	D12L140ER11M	12	140	27	16	7	1÷7	812-203012	ER11M
264-35123	D12L55ER16M	12	55	37	22	7	1÷10	812-203013	ER16M
214-35114	D12L80ER16M	12	80	39	22	7	1÷10	812-203013	ER16M
264-35124	D12L120ER16M	12	120	37	22	7	1÷10	812-203013	ER16M
264-35126	D16L40ER11M	16	40	22	16	7	1÷7	812-203012	ER11M
214-35725	D16L60ER11M	16	60	22	16	7	1÷7	812-203012	ER11M
264-35127	D16L80ER11M	16	80	24	16	7	1÷7	812-203012	ER11M
264-35128	D16L100ER11M	16	100	24	16	7	1÷7	812-203012	ER11M
264-35129	D16L130ER11M	16	130	24	16	7	1÷7	812-203012	ER11M
264-35130	D16L160ER11M	16	160	24	16	7	1÷7	812-203012	ER11M
214-35726	D16L200ER11M	16	200	24	16	7	1÷7	812-203012	ER11M
264-35131	D16L35ER16M	16	35	39	22	7	1÷10	812-203013	ER16M
264-35132	D16L60ER16M	16	60	39	22	7	1÷10	812-203013	ER16M
214-35115	D16L80ER16M	16	80	39	22	7	1÷10	812-203013	ER16M
214-35145	D16L100ER16M	16	100	39	22	7	1÷10	812-203013	ER16M
214-35146	D16L130ER16M	16	130	39	22	7	1÷10	812-203013	ER16M
214-35147	D16L160ER16M	16	160	39	22	7	1÷10	812-203013	ER16M
214-35727	D16L200ER16M	16	200	39	22	7	1÷10	812-203013	ER16M
264-35133	D16L55ER20M	16	55	48	28	9	1÷13	812-203014	ER20M
214-35148	D16L100ER20M	16	100	40	28	9	1÷13	812-203014	ER20M
264-35135	D16L160ER20M	16	160	40	28	9	1÷13	812-203014	ER20M

D5÷D16 Shank without flat • Stelo senza piano • Mango sin plano • Zylinderschaft • Queue cylindrique • Хвостовик без лыски • 柄不带平面

CYLINDRICAL COLLET CHUCKS WITH MINI NUT

SPANNFUTTER MIT ZYLINDERSCHAFT MIT MINI SPANNMUTTER
PORTAPINZAS CILINDRICO CON TUERCA MINI
ЦАНГОВЫЕ ПАТРОНЫ С ЦИЛИНДРИЧЕСКИМ
ХВОСТОВИКОМ С МИНИ-ГАЙКОЙ

PORTAPINZA GAMBO CILINDRICO CON GHIERA MINI
PORTE PINCES QUEUE CYLINDRIQUE AVEC ECROU MINI
带微型螺母的圆柱式弹簧夹头

DIN6499/ISO15488

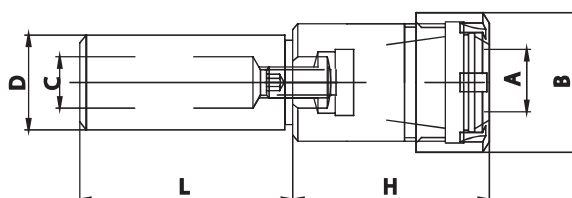

CODE N.	DESCRIPTION	Dh6	L	H	B	C	CLAMPLING CAPACITY	NUT	DESCRIPTION
264-35136	D20L50ER11M	20	50	24	16	7	1÷7	812-203012	ER11M
264-35137	D20L100ER11M	20	100	24	16	7	1÷7	812-203012	ER11M
214-35736	D20L130ER11M	20	130	22	16	7	1÷7	812-203012	ER11M
214-35737	D20L160ER11M	20	160	22	16	7	1÷7	812-203012	ER11M
214-35738	D20L200ER11M	20	200	22	16	7	1÷7	812-203012	ER11M
214-35149	D20L60ER16M	20	60	32	22	11	1÷10	812-203013	ER16M
214-35150	D20L100ER16M	20	100	32	22	11	1÷10	812-203013	ER16M
264-35138	D20L130ER16M	20	130	32	22	11	1÷10	812-203013	ER16M
214-35151	D20L160ER16M	20	160	32	22	11	1÷10	812-203013	ER16M
264-35139	D20L200ER16M	20	200	32	22	11	1÷10	812-203013	ER16M
214-35739	D20L250ER16M	20	250	30	22	11	1÷10	812-203013	ER16M
264-35140	D20L46ER20M	20	46	37	28	11	1÷13	812-203014	ER20M
214-35152	D20L60ER20M	20	60	39	28	11	1÷13	812-203014	ER20M
214-35111	D20L100ER20M	20	100	39	28	11	1÷13	812-203014	ER20M
214-35153	D20L130ER20M	20	130	39	28	11	1÷13	812-203014	ER20M
214-35154	D20L160ER20M	20	160	37	28	11	1÷13	812-203014	ER20M
264-35141	D20L200ER20M	20	200	39	28	11	1÷13	812-203014	ER20M
214-35740	D20L250ER20M	20	250	37	28	11	1÷13	812-203014	ER20M
214-35155	D20L60ER25M	20	60	46	35	11	1÷16	812-203015	ER25M
214-35116	D20L100ER25M	20	100	44	35	11	1÷16	812-203015	ER25M
214-35156	D20L130ER25M	20	130	46	35	11	1÷16	812-203015	ER25M
214-35741	D20L160ER25M	20	160	46	35	11	1÷16	812-203015	ER25M
214-35742	D22L80ER16M	22	80	27	22	11	1÷10	812-203013	ER16M
214-35743	D22L80ER20M	22	80	30	28	11	1÷13	812-203014	ER20M
264-35144	D25L60ER16M	25	60	29	22	11	1÷10	812-203013	ER16M
214-35157	D25L100ER16M	25	100	27	22	11	1÷10	812-203013	ER16M
264-35146	D25L160ER16M	25	160	27	22	11	1÷10	812-203013	ER16M
214-35746	D25L200ER16M	25	200	27	22	11	1÷10	812-203013	ER16M
214-35158	D25L60ER20M	25	60	29	28	13	1÷13	812-203014	ER20M
214-35159	D25L100ER20M	25	100	28	28	13	1÷13	812-203014	ER20M
264-35147	D25L130ER20M	25	130	28	28	13	1÷13	812-203014	ER20M
214-35160	D25L160ER20M	25	160	29	28	13	1÷13	812-203014	ER20M
214-35747	D25L200ER20M	25	200	28	28	13	1÷13	812-203014	ER20M
264-35148	D25L50ER25M	25	50	32	35	13	1÷16	812-203015	ER25M
214-35161	D25L70ER25M	25	70	32	35	13	1÷16	812-203015	ER25M
264-35149	D25L100ER25M	25	100	32	35	13	1÷16	812-203015	ER25M
214-35162	D25L130ER25M	25	130	32	35	13	1÷16	812-203015	ER25M
264-35150	D25L160ER25M	25	160	32	35	13	1÷16	812-203015	ER25M
214-35748	D25L200ER25M	25	200	32	35	13	1÷16	812-203015	ER25M
264-35151	D32L90ER16M	32	90	30	22	11	1÷10	812-203013	ER16M
214-35163	D32L90ER20M	32	90	29	28	13	1÷13	812-203014	ER20M

D19,05÷D32 Shank with flat • Stelo con piano • Mango con plano • Zylinderschaft mit Fläche • Queue cylindrique avec plat • Хвостовик с лыской • 柄带平面



CYLINDRICAL COLLET CHUCKS WITH STANDARD NUT

SPANNFUTTER MIT ZYLINDERSCHAFT MIT STANDARD SPANNMUTTER
PORTAPINZAS CILINDRICO CON TUERCA ESTANDAR
ЦАНГОВЫЕ ПАТРОНЫ С ЦИЛИНДРИЧЕСКИМ
ХВОСТОВИКОМ СО СТАНДАРТНОЙ ГАЙКОЙ

PORTAPINZA GAMBO CILINDRICO CON GHIERA STANDARD
PORTE PINCES QUEUE CYLINDRIQUE AVEC ECROU STANDARD
帶标准螺母的圆柱式弹簧夹头

DIN6499/ISO15488

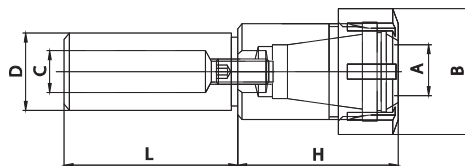

CODE N.	DESCRIPTION	Dh6	L	H	B	C	CLAMPING CAPACITY	NUT	DESCRIPTION
214-35759	D16L130ER16	16	130	36	32	7	1÷10	812-203005	ER16
264-35155	D16L70ER25	16	70	46	42	9	1÷16	812-203001	ER25
264-35156	D20L50ER16	20	50	31	32	11	1÷10	812-203005	ER16
214-35127	D20L100ER16	20	100	31	32	11	1÷10	812-203005	ER16
214-35770	D20L130ER16	20	130	31	32	11	1÷10	812-203005	ER16
264-35158	D20L46ER20	20	46	36	35	11	1÷13	812-203006	ER20
264-35159	D20L60ER20	20	60	36	35	11	1÷13	812-203006	ER20
264-35160	D20L100ER20	20	100	36	35	11	1÷13	812-203006	ER20
214-35119	D20L50ER25	20	50	46	42	11	1÷16	812-203001	ER25
214-35128	D20L100ER25	20	100	44	42	11	1÷16	812-203001	ER25
264-35162	D20L160ER25	20	160	46	42	11	1÷16	812-203001	ER25
264-35163	D20L50ER32	20	50	54	50	13	2÷20	812-203002	ER32
214-35129	D20L100ER32	20	100	54	50	13	2÷20	812-203002	ER32
214-35775	D25L60ER16	25	60	27	32	11	1÷10	812-203005	ER16
264-35171	D25L60ER20	25	60	28	35	13	1÷13	812-203006	ER20
214-35120	D25L50ER25	25	50	44	42	13	1÷16	812-203001	ER25
214-35782	D25L70ER25	25	70	32	42	13	1÷16	812-203001	ER25
214-35130	D25L100ER25	25	100	44	42	13	1÷16	812-203001	ER25
264-35174	D25L160ER25	25	160	32	42	13	1÷16	812-203001	ER25



Accessories
Accessori
Zubehör
Accesorios
Accessoires
Принадлежности
零件

D14÷D16 Shank without flat • Stelo senza piano • Mango sin plano • Zylinderschaft • Queue cylindrique • Хвостовик без лыски • 柄不带平面

D19,05÷D25 Shank with flat • Stelo con piano • Mango con plano • Zylinderschaft mit Fläche • Queue cylindrique avec plat • Хвостовик с лыской • 柄带平面

CYLINDRICAL COLLET CHUCKS WITH STANDARD NUT

SPANNFUTTER MIT ZYLINDERSCHAFT UND STANDARD SPANNMUTTER
PORTAPINZAS CILINDRICO CON TUERCA ESTANDAR
ЦАНГОВЫЕ ПАТРОНЫ С ЦИЛИНДРИЧЕСКИМ
ХВОСТОВИКОМ СО СТАНДАРТНОЙ ГАЙКОЙ

PORTAPINZA GAMBO CILINDRICO CON GHIERA STANDARD
PORTE PINCES QUEUE CYLINDRIQUE AVEC ECROU STANDARD
帶标准螺母的圆柱式弹簧夹头

DIN6499/ISO15488

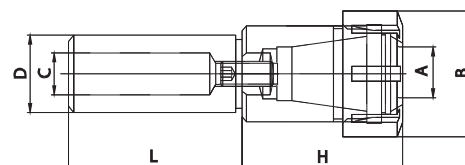

CODE N.	DESCRIPTION	Dh6	L	H	B	C	CLAMPING CAPACITY	NUT	DESCRIPTION
264-35175	D25L50ER32	25	50	53	50	13	2÷20	812-203002	ER32
264-35176	D25L70ER32	25	70	53	50	13	2÷20	812-203002	ER32
214-35131	D25L100ER32	25	100	54	50	13	2÷20	812-203002	ER32
264-35177	D25L130ER32	25	130	54	50	13	2÷20	812-203002	ER32
214-35132	D32L70ER25	32	70	30	42	19	1÷16	812-203001	ER25
264-35743	D32L100ER25	32	100	28	42	19	1÷16	812-203001	ER25
264-35185	D32L50ER32	32	50	53	50	23	2÷20	812-203002	ER32
214-35117	D32L70ER32	32	70	53	50	23	2÷20	812-203002	ER32
264-35186	D32L100ER32	32	100	53	50	23	2÷20	812-203002	ER32
214-35133	D32L120ER32	32	120	38	50	23	2÷20	812-203002	ER32
214-35134	D32L150ER32	32	150	38	50	23	2÷20	812-203002	ER32
264-35188	D32L70ER40	32	70	60	63	23	3÷30	812-203003	ER40
264-35189	D40L70ER25	40	70	44	42	19	1÷16	812-203001	ER25
214-35136	D40L70ER32	40	70	34	50	23	2÷20	812-203002	ER32
264-35748	D40L100ER32	40	100	30	50	23	2÷20	812-203002	ER32
214-35137	D40L130ER32	40	130	34	50	23	2÷20	812-203002	ER32
214-35138	D40L80ER40	40	80	68	63	28	3÷30	812-203003	ER40
264-35191	D40L130ER40	40	130	60	63	28	3÷30	812-203003	ER40
264-35192	D50L125ER32	50	125	43	50	23	2÷20	812-203002	ER32
264-35193	D50L160ER32	50	160	32	50	23	2÷20	812-203002	ER32
264-35752	D50L125ER40	50	125	37	63	28	3÷30	812-203003	ER40

D25÷D60 Shank with flat • Stelo con piano • Mango con plano • Zylinderschaft mit Fläche • Queue cylindrique avec plat • Хвостовик с лыской • 柄不带平面

CYLINDRICAL COLLET CHUCKS WITH HEXAGONAL NUT

SPANNFUTTER MIT ZYLINDERSCHAFT MIT SECHSKANT MUTTER PORTAPINZA GAMBO CILINDRICO CON GHIERA ESAGONALE
 PORTAPINZAS CILINDRICO CON TUERCA HEXAGONAL PORTE PINCES QUEUE CYLINDRIQUE AVEC ECROU EXAGONAL
 ЦАНГОВЫЕ ПАТРОНЫ С ЦИЛИНДРИЧЕСКИМ ХВОСТОВИКОМ С ШЕСТИГРАННОЙ ГАЙКОЙ 帶六角螺母的圆柱式弹簧夹头

DIN6499/ISO15488

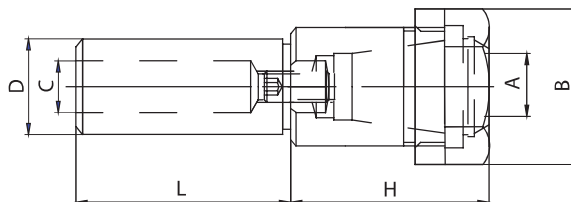

CODE N.	DESCRIPTION	Dh6	L	H	B	C	CLAMPLING CAPACITY	NUT	DESCRIPTION
214-35784	D16L60ER16E	16	60	36	28	7	1÷10	812-203009	ER16
214-35795	D20L50ER16E	20	50	31	28	11	1÷10	812-203009	ER16
214-35796	D20L100ER16E	20	100	31	28	11	1÷10	812-203009	ER16
264-35714	D25L60ER20E	25	60	28	34	13	1÷13	812-203010	ER20

D14÷D16 Shank without flat • Stelo senza piano • Mango sin plano • Zylinderschaft • Queue cylindrique • Хвостовик без лыски • 柄不带平面
D19,05÷D32 Shank with flat • Stelo con piano • Mango con piano • Zylinderschaft mit Fläche • Queue cylindrique avec plat • Хвостовик с лыской • 柄带平面

CYLINDRICAL DOUBLE COLLET CHUCKS WITH MINI NUT

SPANNFUTTER MIT ZYLINDERSCHAFT MIT MINI SPANNMUTTER PORTAPINZA DOPPI GAMBO CILINDRICO CON GHIERA MINI
 PORTAPINZAS CILINDRICO DOBLE CON TUERCA MINI PORTE PINCES QUEUE CYLINDRIQUE AVEC ECROU MINI
 ДВУСТОРОННИЕ ЦАНГОВЫЕ ПАТРОНЫ С МИНИ-ГАЙКОЙ 帶微型螺母的圆柱式双弹簧夹头

DIN6499/ISO15488

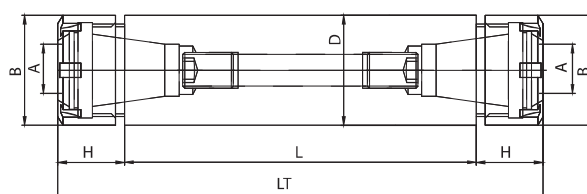

CODE N.	DESCRIPTION	Dh6	L	H	LT	B	CLAMPLING CAPACITY	NUT	DESCRIPTION
214-35703	D20L37ER16MD	20	37	21,5	80	22	1÷10	812-203013	ER16M
214-35704	D20L57ER16MD	20	57	21,5	100	22	1÷10	812-203013	ER16M
214-35705	D20L67ER16MD	20	67	21,5	110	22	1÷10	812-203013	ER16M
214-35711	D25L47ER16MD	25	47	21,5	90	22	1÷10	812-203013	ER16M
214-35713	D25L82ER20MD	25	82	24	130	28	1÷13	812-203014	ER20M
264-35758	D32L82ER20MD	32	82	24	130	28	1÷13	812-203014	ER20M

