

# D'ANDREA MODULHARD'ANDREA

**TRD 25~80** Ø 28 ~ 160

- DOUBLE-BIT TESTAROSSA
- TESTAROSSA ZWEISCHNEIDERKÖPFE
- TESTAROSSA DE DOS CUCHILLAS
- DOUBLE TRANCHANT TESTAROSSA
- TESTAROSSA BITAGLIENTE

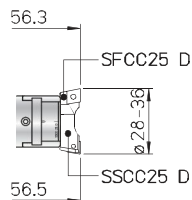
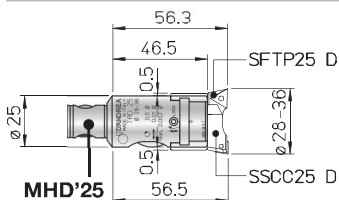
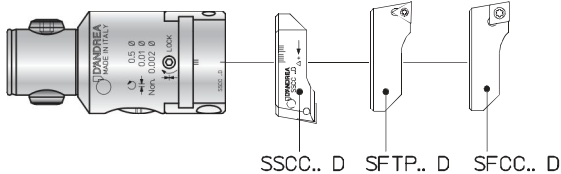

**TRD 25**  
Ø 28 ~ 36

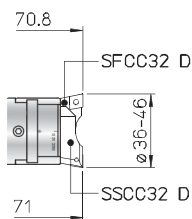
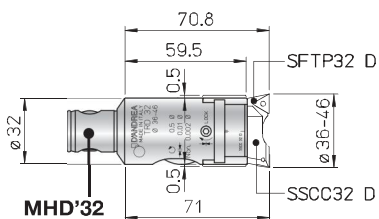

**TRD 32**  
Ø 36 ~ 46

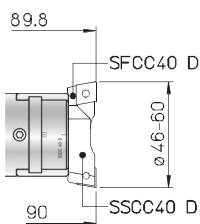
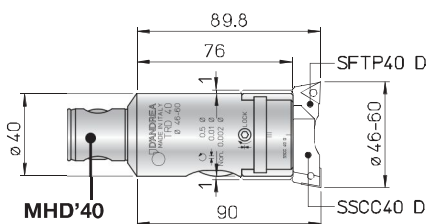

**TRD 40**  
Ø 46 ~ 60

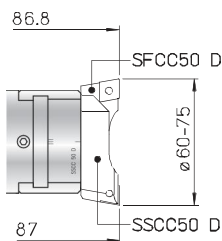
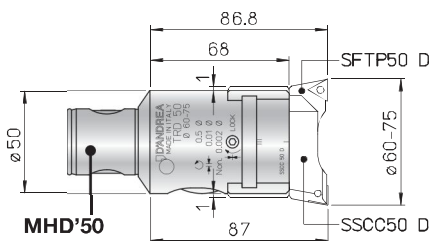

**TRD 50**  
Ø 60 ~ 75

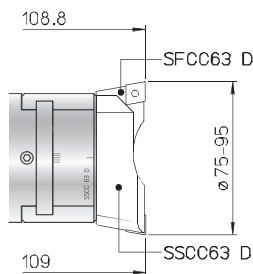
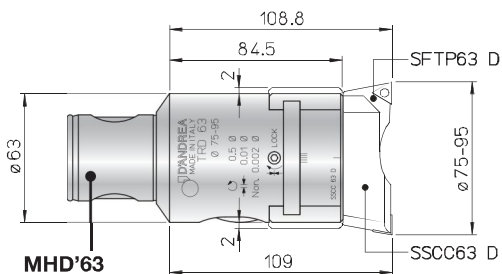

**TRD 63**  
Ø 75 ~ 95

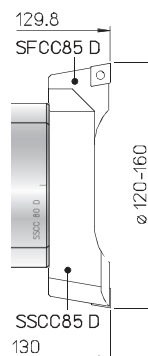
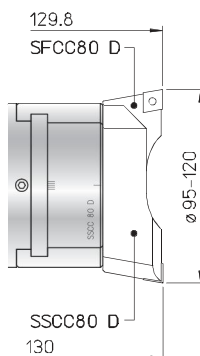
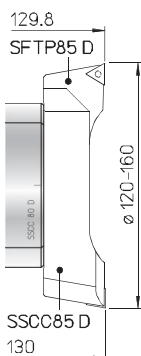
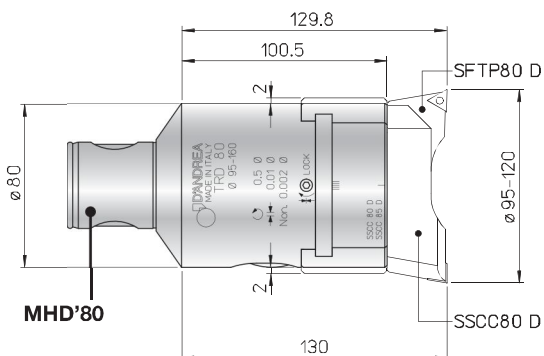

**TRD 80**  
Ø 95 ~ 160



- DOUBLE-BIT TESTAROSSA
- TESTAROSSA ZWEISCHNEIDERKÖPFE
- TESTAROSSA DE DOS CUCHILLAS
- DOUBLE TRANCHANT TESTAROSSA
- TESTAROSSA BITAGLIENTE

TRD



10  $\mu$ m  
nonio  
vernier 2  $\mu$ m

REF.	CODE	Kg.
TRD 25	455022500571	0.2
TRD 32	455023200711	0.35
TRD 40	455024000901	0.7
TRD 50	455025000861	1.5
TRD 63	455026301081	2.7
TRD 80	455028001291	4.8

- BIT-HOLDERS FOR DOUBLE-BIT TESTAROSSA
- PLATTENHALTER FÜR TESTAROSSA ZWEISCHNEIDERBOHRKÖPFE
- ASIENTOS PARA TESTAROSSA DE DOS CUCHILLAS
- DOUBLE TRANCHANT TESTAROSSA
- SEGGI PER TESTAROSSA BITAGLIENTE

SS-SF

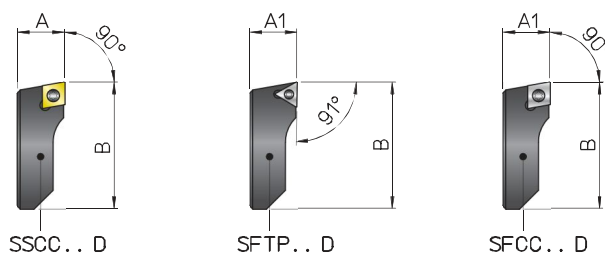

REF.	CODE	A	A1	B	$\Delta$	$\square$	$\square$	$\square$	Kg.
SSCC 25 D	470500525220	10	-	24	-	CCMT 0602..	TS 25	TORX T08	0.008
SSCC 32 D	470500532220	11.5	-	30	-				0.015
SSCC 40 D	470500540220	14	-	40	-				0.03
SSCC 50 D	470500550220	19	-	54	-				0.06
SSCC 63 D	470500563220	24.5	-	68	-	CCMT 09T3..	TS 4	TORX T15	0.15
SSCC 80 D	470500580220	29.5	-	87	-				0.3
SSCC 85 D	470500585221		-	107.4	-				0.4
SFTP 25 D	470500525030	-	9.8	24	TPGX 0902..	-	CS 250T		0.008
SFTP 32 D	470500532030	-	11.3	30					0.015
SFTP 40 D	470500540030	-	13.8	40					0.03
SFTP 50 D	470500550030	-	18.8	54					0.06
SFTP 63 D	470500563030	-	24.3	68	TPGX 1103..	-	CS 300890T	TORX T08	0.15
SFTP 80 D	470500580030	-	29.3	87					0.3
SFTP 85 D	470500585031	-		107.4					0.4
SFCC 25 D	470500525020	-	9.8	24	-	CCGT 0602..	TS 25	TORX T08	0.008
SFCC 32 D	470500532020	-	11.3	30	-				0.015
SFCC 40 D	470500540020	-	13.8	40	-				0.03
SFCC 50 D	470500550020	-	18.8	54	-				0.06
SFCC 63 D	470500563020	-	24.3	68	-	CCGT 09T3..	TS 4	TORX T15	0.15
SFCC 80 D	470500580020	-	29.3	87	-				0.3
SFCC 85 D	470500585021	-		107.4	-				0.4