

FH

BAH

TA.CP

TA

MOX

HT

4-67

VH

TSI/TSX

T

MT-TC-TC3



TA013.P

TESTA AD ANGOLO - ANGLE HEAD



7,5 KG

10,5 KG

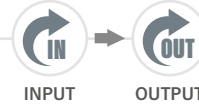
PESO
WEIGHT

INPUT

OUTPUT

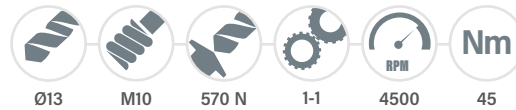
ROTAZIONE
ROTATION

Ø13

M10

570 N

1-1

4500

45

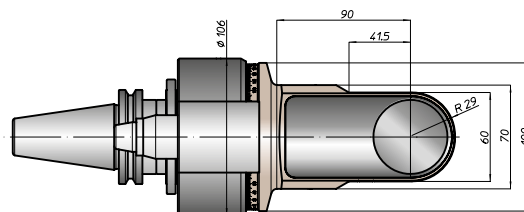
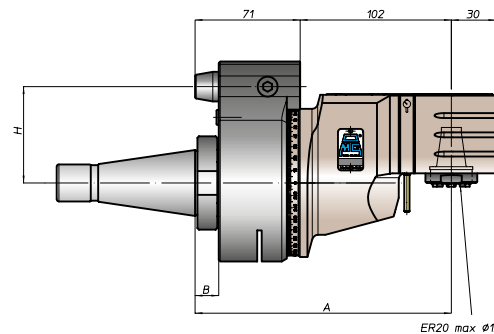
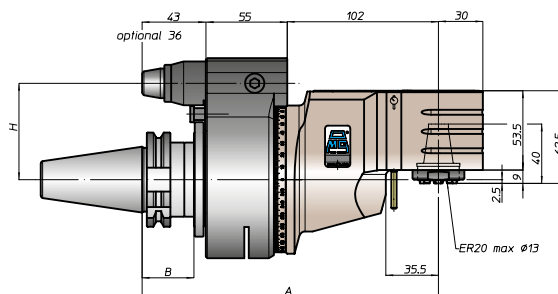
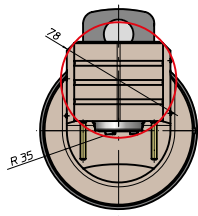
CARATTERISTICHE
FEATURESØ16
PORTAFRESE
FACE MILL ARBORØ12
WELDON
WHISTLE-NOTCHHSK32
DIN69893-HSKMANDRINI
DISPONIBILI
AVAILABLE
SPINDLESCONO
SHANK

DIN69871



ANSIB5.50



BT



HSK

DIN69893

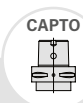

CAPTO

ISO26623

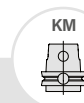

KM



DIN2080



NMTB

ANSIB5.18

SIZE

40

45

50

40

50

40

50

63

80

100

C5

C6

C8

63

80

100

40

50

40

50

A

200

200

200

208

209

204

200

170

176

173

176

B

35

35

35

45

44

46

39

41

13

16

13

16

H STANDARD

65

80

65

80

65

80

65

80

65

80

65

80

65

80

65

80

H OPTIONAL

110

110

110

110

110

110

110

110

For DIN69871, ANSIB5.50 and BT, dual contact as option

